

SI

TRUE DC Solar Isolator



Brighter **Solutions**

AC vs DC Safe Switching

As any electrician is aware the nature of DC switching has to be considered with care because on disconnection an arc can occur that is more arduous than that produced with an AC load because there is no zero point on DC. The nature of this arc means that design considerations have to be made within the switch in order to quench this phenomenon; that not only includes significant contact gaps with high speed of operation, but also thermal transmissive materials.

What must be considered is that any AC isolator is predominantly designed with materials chosen such that the load will be AC. This means that the load supply will be a 50/60Hz sine wave, whether it be 230VAC or 400VAC, etc. When switching AC it should be remembered that the nature of the load supply will always pass through 0VAC twice in every cycle and therefore although loads can be arduous in type the supply is self-extinguishing. By that we mean that even if the isolator switches at peak load and an arc is formed between contacts, the action of the supply reducing to 0V means that the load will tend to zero and the arc will be extinguished.

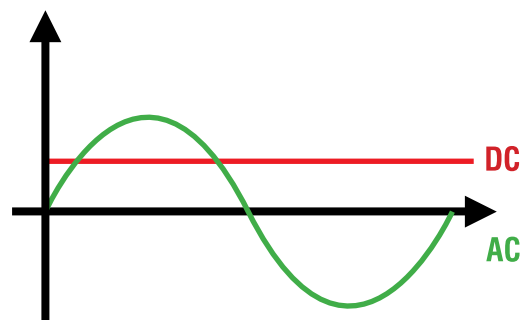

DC load, on the other hand, is always there and unless the load becomes zero, the power being pulled through the contacts will always be the same. So if the load is 500VDC 25A it will be 500V 25A now, in 1s, in 1min, in 1hour – that is constant. In this case, unlike the AC above if you switch “OFF” on load you will also be switching “ON” on load; DC does not go through a 0V level unless there is system supply failure (or some other fault).

So if switching a loaded DC circuit, especially at the high voltages that can be found in PV installations (up to 1000V or more), current will continue to flow over the opening contact gap due to the partial breakdown of the air between the contacts. This phenomenon is viewed as an arc between the contacts and it will only stop when the distance between the contacts, and so the air gap, becomes large enough to prevent the continued electrical breakdown.

In order to replicate in DC, the self-extinguishing nature of AC, then switching OFF the load should occur quickly and in a switch that is designed with a contact system that allows enough distance to break the DC arc and dissipate the arc energy present during such a switching operation. Therefore, in order to perform such switching safely a fast operating switch-disconnector is necessary.

What is a Switch and what is a Switch-Disconnecter?

We are all familiar with a switch. In its basic form we all know it as having one or more sets of electrical contacts that are connected to a load and manually operated to either close or open the contacts in order to make them conducting or non-conducting.

However, there is a European standard covering switches and switch-disconnectors which is EN 60947-3, and in this document there are definitions of industrial switches.

A **switch** is a mechanical switching device used for making and breaking current in an electrical circuit within certain operational conditions.

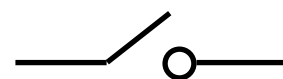

A **disconnector** is a mechanical switching device used for carrying current in an electrical circuit under normal conditions and for providing off-load isolation, therefore it is only intended to be used for isolation once the current flow is negligible or has been interrupted by another device.

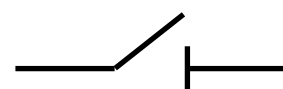

A **switch-disconnector** is a mechanical switching device that meets the requirements for utilisation as both a switch and a disconnector, so it can be used to make and break current whilst also giving on-load isolation.



Electrical installations, whether it be residential or industrial, normally follow a set of regulations in order to ensure a safe living or working environment. In the UK these rules are specified in the IET wiring regulations BS 7671. Within these regulations Chapter 53 Section 537 covers the requirement for Isolation and Switching, whilst Section 712 contains specific requirements relating to the installation of PV power supply systems including those with AC modules.

If a switch is not rated or classified as a disconnector or switch-disconnector then BS 7671 does not allow for its use in an electrical circuit as safety isolation switch. EN 60947-3 is listed in BS 7671 Table 53.2 as an appropriate standard covering product isolation, emergency switching and functional switching; and as IMO designs and manufactures its range of switch-disconnectors (more commonly referred to as isolators) to this European Standard our range of Solar Isolators therefore meet the requirements stipulated under BS 7671.

Utilisation Categories

Utilisation Categories as are covered in the European Standards EN 60947-1 & EN60947-3 and define an equipment's intended application. The list of both AC and DC categories for low-voltage switchgear and controlgear are stated in EN 60947-1 Annex A along with the relevant product standards.

Manufacturers of both switchgear and controlgear should include in their technical product data all the operational ratings for the utilisation categories for which a product is designed and as such this should remove the confusion for users and designers in their selection of the correct product.

If we consider PV installations where there are requirements for switchgear being used on the DC side then the system falls typically within two categories below (for which the relevant standard is EN 60947-3)

DC-21 Switching of resistive loads, including moderate overloads

DC-22 Switching of mixed resistive and inductive loads, including moderate overloads

DC-PV1 Switching of single PV string(s) without reverse and overcurrents

DC-PV2 Switching of several PV strings with reverse and overcurrents

Compliance to the EN60947-3 utilisation categories involves the products completing a number of tests, these include the "Making and Breaking Capacity" (section 7.2.4.1/D7.2.4.1) and "Operational Performance" (section 7.2.4.2/D7.2.4.2). Verification of the operational making and breaking capacities are stated by reference to the rated operational voltage and rated operational current according to Table 3 and Table D7 (see extracts below).

Test Conditions for Making & Breaking Capacities

Utilisation categories	Rated operational categories	Making			Breaking			Number of operating cycles
		I/I_e	U/U_e	L/R ms	I_c/I_e	U_r/U_e	L/R ms	
DC-21A - DC-21B	All values	1.5	1.05	1	1.5	1.05	1	5
DC-22B	All values	4	1.05	2.5	4	1.05	2.5	5
DC-PV1	All values	1.5	1.05	1	1.5	1.05	1	5
DC-PV2	All values	4	1.05	1	4	1.05	1	5

Test Conditions for Number of On Load Operating Cycles

Utilisation categories	Number of operating cycles per hour	Number of operating cycles					
		A categories			B categories		
		Without current	With current	Total	Without current	With current	Total
DC-21A/B & DC-22B	120	8,500	1,500	10,000	1,700	300	2,000
DC-PV1 & DC-PV2	120	9,700	300	10,000	-	-	-

Utilisation categories	Rated operational categories	Making			Breaking		
		I/I_e	U/U_e	L/R ms	I_c/I_e	U_r/U_e	L/R ms
DC-21A - DC-21B	All Values	1	1	1	1	1	1
DC-22B	All Values	1	1	2	1	1	2
DC-PV1	All Values	1	1	1	1	1	1
DC-PV2	All Values	1	1	1	1	1	1

I =making current I_c =breaking current I_e =rated operational current
 U =applied voltage U_e =rated operational voltage U_r =operational frequency or d.c recovery voltage

PV Installation Isolation

PV installations consist of the DC side, the Inverter and the AC side with isolation required for both the PV-array to the inverter and for the AC supply from the load, particularly where the system is connected to the Distributed Network, this is a stipulation in G83/1. In some instances the “Guide to Installation of PV Systems” allows inverter and DC string isolation to be provided by the same device, for example the PV plug and socket connectors, but this is only deemed suitable for smaller systems and the connectors must be labelled appropriately. Generally IMO would always recommend the use of a suitably rated DC isolator.

DC Isolator Selection

BS 7671 states that a method of isolation must be provided on the DC side of a PV installation and this can be provided by a switch-disconnector as classified under EN 60947-3 this is also covered by “Guide to the installation of PV systems”. The Guide also stipulates that the switch must isolate all live conductors (typically double pole to isolate PV array positive and negative conductors).

BS 7671 specifies that isolators that are in compliance with EN 60947-3 are appropriate for use in PV systems. The isolator rating must consider the maximum voltage and current of the PV string being switched and these parameters then adjusted in accordance with the safety factors stipulated in current standards. This should then be the minimum required rating of the isolator.



$$\text{Voltage} = N_s \times V_{oc} \times 1.15 \quad \text{Current} = N_p \times I_{sc} \times 1.25$$

N_s - Number of panels connected in series
 V_{oc} – Open-Circuit Voltage (from module manufacturer’s data)

N_p - Number of strings connected in parallel
 I_{sc} – Short-Circuit Current (from module manufacturer’s data)

The isolator should also be suitable for use in the appropriate application which in PV installations is normally considered to be either DC-21A, DC-21B, DC-22A or DC-22B. Normally isolation of the DC supply from the inverter would not be a regular occurrence and therefore generally ratings for DC-21B or DC-22B would, as a minimum, be necessary; although category A types (as previously covered in Utilisation Categories) would be advantageous due to their capability of a higher number of switching operations, and therefore a longer guaranteed life.

AC Isolator Selection

AC Isolators are used in both stand-alone grid or network distributed systems. If connected to the distributed network then G83/1 stipulates the PV system must be connected directly to an isolation switch that is wired so as to isolate both the live and neutral conductors, capable of being secured in the “OFF” position and in an accessible location within the installation. In a stand-alone system IMO recommend that a lockable OFF isolation switch is similarly used within the installation. BS 7671 specifies that isolators that are in compliance with EN 60947-3 are appropriate for use in PV systems.

Unlike a DC isolator that is required to switch both the positive and negative conductors, an AC isolator should be chosen with regards to the supply being single phase, which is typically found in domestic installations or three phase, which is typical for commercial or industrial installations. Ideally for single phase a 2pole isolator should be used to switch the live and neutral line (earth constantly connected) whilst a 4pole isolator would be used to switch the 3 voltage lines and neutral (earth constantly connected).

The isolator rating should be based on the inverter output which is normally specified per phase, that is line to neutral, and for example maybe shown as 20A at 230VAC; if this output is from a three phase unit then the AC isolator must be rated to for the line-to-line voltage which would typically be 415VAC.

With both AC and DC isolators the ambient temperature of the environment in which the switch is mounted must be considered as most industrial switches are nominally rated for use in 35°C. However, if the isolator is to be used in an area where solar activity is prevalent, thereby making more efficient use of the installation and greater yield, or in an enclosed space such as a loft or that of an inverter enclosure, then an isolator capable of handling the elevated temperatures should be selected.

All IMO Solar Isolators are capable of being installed in areas where high ambient temperatures of up to +45°C can be found. In installations of higher temperatures, our open style product can be used up to +65°C, however, you should ensure safe operating conditions and correct mounting of the product.

Why use an IMO DC Solar Isolator?

IMO Precision Controls offers a range of True DC Isolators specifically designed for use in Solar PV installations in accordance with EN 60364-7-712. The IMO design incorporates a user independent switching action so as the handle is moved it interacts with a spring mechanism which, upon reaching a set point, causes the contacts to “SNAP” over thereby ensuring a very fast break/make action. This mechanism means that the disconnection of the load circuits and suppression of the arc, produced by a constant DC load, is normally extinguished in 3ms using the specific pole suppression chambers incorporated within the design.

Many alternative solutions, particularly those based upon an AC isolator designs which use bridge contacts, have been modified and rated for DC operation. These types of product have a switching speed that is directly linked to operator speed therefore, slow operation of the handle results in slow contact separation of the contacts which can produce arcing times of 100ms or more. Also in these switches the contact surface is also the surface upon which arcs tend to form; therefore, any surface damage or sooting caused by the arcing is likely to have a detrimental effect on the isolator’s contact resistance and its longevity.

The IMO Solar Isolator range is offered in a number of configurations all rated for installation and use as switch-disconnects and all with options allowing for “LOCKABLE OFF” operation. Although able to offer the industry standard two position 90° handle operation from LOCKABLE OFF-ON, IMO have also introduced a **SAFE-LOCK** patented handle that allows for three rotational positions relating to ON-OFF-LOCK. The facility offered by this design gives a LOCK position that is removed from the OFF setting ensuring the handle can be placed in its own unique position when locked, which is fully compliant with IEC 60947-1 section 8.2.5.2.1 for classification as an isolator or switch disconnect. When this design is used within the IMO enclosed Solar Isolators it ensures that engineering access can only be attained to the enclosure when the handle is in the OFF position; whilst the “LOCK” position ensures secure power isolation combined with non-access to the enclosure (when the isolator block is secured with supplied screws) and thereby significantly reducing the risks of tampering when maintenance/repair is carried out on equipment in-line after the isolator, **SAFE-LOCK**. Once any work has been undertaken the locking mechanism can then be removed and the isolator returned to its normal operational mode.



IMO Solar Isolators use a rotary “knife contact” mechanism so when the unit is operated the handle movement gives a double make/break per contact set. As DC load switching creates arcing the design is such that this only occurs on the corners of the switching parts meaning that the main contact is made on an area where no arcing has occurred. The rotary contact mechanism methodology used in the IMO Solar Isolators means that, when the isolator is operated, a self-cleaning action occurs on the arcing points and contact surfaces thereby producing good high vibration resistant contact integrity, with reduced contact resistance. This IMO contact system ensures that power loss per pole is kept as low as possible and consistent over the life of the product unlike conventional style isolators where entrapment of contaminants, and then subsequent compression on lateral operation, can lead to variable and increasing contact resistance and hence per pole losses.

As indicated in the section about **Utilisation Categories**, the IMO product is satisfactory for use in installations classified as either DC-PV1, DC-PV2, DC-21A, DC-21B or DC-22A, and so suitable for a high number of “off load” operations (without current) and also a high number of operating cycles “on load” (with current).

Unlike a number of DC isolators on the market, the IMO solar isolator is also polarity independent, which means that there is no requirement for specific directional wiring of the PV supply. A further advantage of the IMO contact mechanism is that, in the event of the supply to earth failure, the high short circuit current pulls the contacts together thereby giving a high short circuit withstand current of up to 2400A (product dependent). PV residential installations are typically 1000VDC however, IMO Solar Isolators already have the capability to operate up to 1500VDC.

In the move towards safer installations of PV systems, whether it be in a domestic or industrial environment, consideration has to often be given to the materials and the risk of fire hazard that they pose. Ratings referred to under the UL 94 category are deemed generally acceptable for compliance with this requirement as this cover tests for flammability of polymeric materials used for parts in devices and appliances. Although there are 12 flame classifications specified in UL 94, there are 6 which relate to materials commonly used in manufacturing enclosures, structural parts and insulators found in consumer electronic products. These are 5VA, 5VB, V-0, V-1, V-2 and HB.

It is because of this that the IMO Solar Isolator range is constructed of materials that significantly reduce the risk of a fire hazard and in particular our enclosed installation style products for which the main plastic enclosure is rated at UL 94V-0 and the handles are UL 94V-2 rated. The classification criteria for each of these ratings is found in of the UL 94 Table 8.1 (see extract below).

Criteria conditions	V-0	V-1	V-2
Afterflame time for each individual specimen t1 or t2	≤10s	≤10s	≤30s
Total afterflame time for any condition set (t1 plus t2 for the 5 specimens)	≤50s	≤250s	≤250s
Afterflame puts afterglow time for each individual specimen after the second flame application (t2+t3)	≤30s	≤60s	≤60s
Afterflame or afterglow of any specimen up to the holding clamp	No	No	No
Cotton indicator ignited by flaming particles or drops	No	No	Yes

The installation requirements and environments of PV systems can vary significantly and the IMO Solar Isolator has been designed such that it can offer a wide range of configurations depending upon the users' requirement. Also the IMO Solar Isolator range includes models that, when mounted in accordance with their respective instructions and with the appropriate IMO handle, offer suitable protection up to IP66 (EN 60529) and NEMA 4X (Nema 250, UL508).

With the advent of more worldwide installations and the requirements laid down in many country's national wiring publications for the use of DC switches in PV installations, the IMO Solar Isolators have also been assessed and tested under the latest UL standard UL508i which has been specifically written to cover the use of "Manual Disconnect Switches intended for use in Photovoltaic Systems".

This UL508i standard specifically covers switches rated up to 1500 V that are intended for use in an ambient temperatures of -20°C to +50°C, and that are suitable for use on the load side of PV branch protection devices. In order to comply with this standard the IMO DC Isolators has to pass an overload test, at +50°C, of 50 cycles at 200% of rated current; followed by an endurance test of 6000 cycles (6 cycles/min) at rated load (Ith) and a further 4000 cycles with no current.

The IMO DC Isolator has successfully attained certification under the UL508i standard and as such is suitable for use as a disconnection method for the isolation of the output of DC PV array where it is to be connected to a DC/AC inverter.

Examples of Typical PV Installations

Single String System – 3kW Output Single Phase

Consider two potential configurations for a typical 3kW system which would supply 13A at 230VAC:

Inverter: Input: 600VDC (V_{OC}), 16A (I_{DC}), 32A ($I_{DC\ max}$) Output: 230VAC (V_{AC}), 13A (I_{AC}), 17.2A ($I_{AC\ max}$)
 Solar Panel: 60V (V_{OC}), 8A (I_{SC}) No. of panels: 8
 Calculation: $V = 8 \times 60 \times 1.15 = 552V$ $I = 8 \times 1.25 = 10A$

For this configuration, the IMO SI16-PEL64R-2 rated at 16A for 700VDC is suitable for the DC switch and the PE69-3020 rated at 20A is suitable for the AC switch.

Inverter: Input: 750VDC (V_{OC}), 15A (I_{DC}), 28A ($I_{DC\ max}$) Output: 230VAC (V_{AC}), 13A (I_{AC}), 16A ($I_{AC\ max}$)
 Solar Panel: 60V (V_{OC}), 8A (I_{SC}) No. of panels: 10
 Calculation: $V = 10 \times 60 \times 1.15 = 895.62V$ $I = 8 \times 1.25 = 10A$

For this configuration, the IMO SI25-PEL64R-2 would still be suitable as it is rated at 16A for 800VDC, however the IMO SI25-PEL64R-2 rated at 16A for 900VDC would allow for a greater margin of safety. The PE69-3020 rated at 20A is suitable for the AC switch.

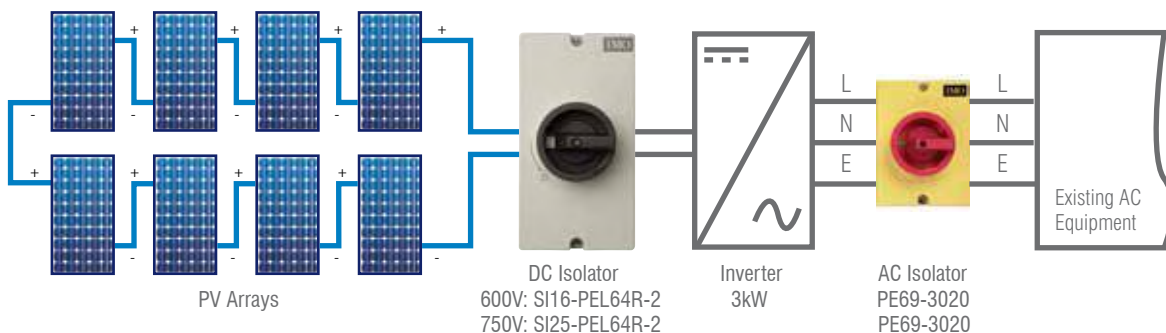

Dual String System – 5kW Output Single Phase

Consider a typical 5kW system which would supply 22A at 230VAC:

Inverter:	Input (per string): 600VDC (V_{OC}), 18A (I_{DC}), 36A ($I_{DC\ max}$)	Output: 230VAC (V_{AC}), 25A ($I_{AC\ max}$)
Solar Panel:	64.9V (V_{OC}), 6.46A (I_{SC}), 5.98A (I_{mpp}), 327Wp (P_{nom})	No. of panels: 8 per string
Calculation:	$V = 8 \times 64.9 \times 1.15 = 597.08V$ $I = 6.46 \times 1.25 = 8.08A$	

For this configuration, each string is to be switched at these levels so the IMO SI16-PEL64R-4 rated at 16A for 700VDC per string is suitable for the DC switch and the PE69-3025 rated at 25A is suitable for the AC switch.

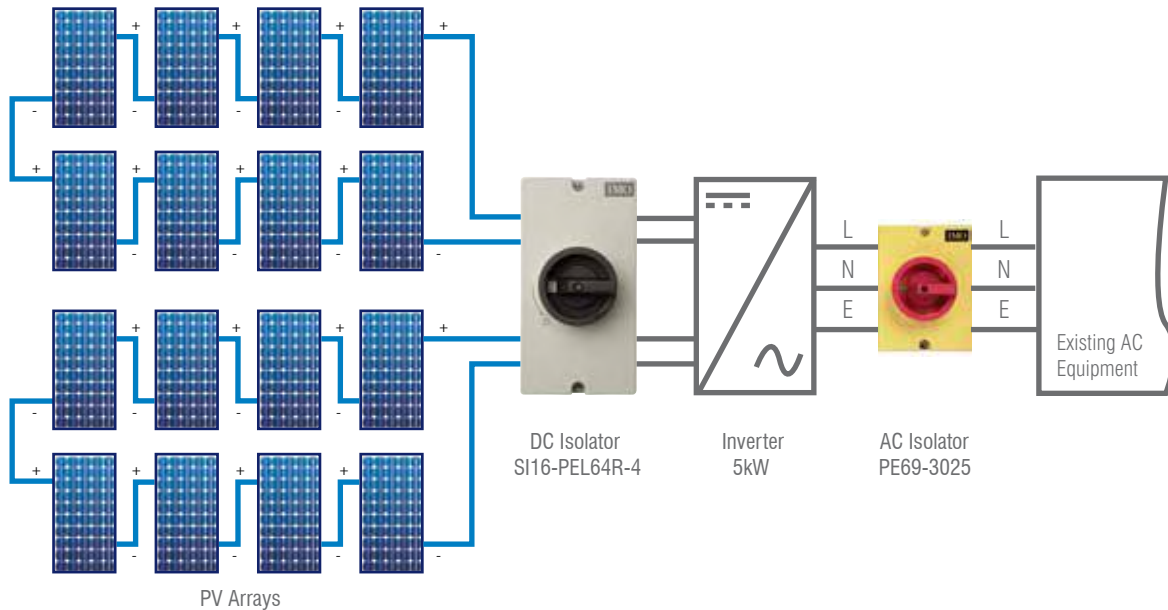

High Voltage Multi-string System – 12.5kW Output Three Phase

Inverter:	Input (per string): 900VDC (V_{OC}), 18A (I_{DC}), 36A ($I_{DC\ max}$)	Output: 4000VAC (V_{AC}), 20A ($I_{AC\ max}$)
Solar Panel:	64.9V (V_{OC}), 6.46A (I_{SC}), 5.98A (I_{mpp}), 327Wp (P_{nom})	No. of panels: 12 per string
Calculation:	$V = 12 \times 64.9 \times 1.15 = 895.62V$ $I = 6.46 \times 1.25 = 8.08A$	

For this system there are several options to consider. If each string is to be switched individually then the SI25-PEL64R-2 rated at 11A for 1000VDC is suitable for the DC switch. If there is a requirement to isolate the strings as pairs then the SI25-PEL64R-4 is suitable. If all strings are to be isolated using one DC isolator then the IMO SI25-PEL64R-8 is suitable. The PE69-3025 rated at 25A is suitable for the AC switch in each case.

Alternatively, if the requirement is to still have the capability of isolating each string individually whilst retaining a single housing unit, then an IMO distribution box populated with SI25-DBL-2 is suitable. These devices use the same switch block as the SI25-PEL64R-2 so have the same rating of 11A at 1000VDC.

This document is meant as a guide and IMO Precision Controls shall not be liable in any event whatsoever for any indirect, special or consequential damages, arising out of the use of the products covered by this document at any time or howsoever caused by the goods. IMO Precision Controls excludes any warranty, condition or statement, express or implied, statutory or otherwise, as to quality, merchantability, or fitness of the goods for any particular purpose.

Over 5 Million Installed Units ZERO FAILURES



In solar installation, the DC isolator is like a vehicle air-bag. You never know it really works until you need it. So it's good to know that the IMO SI has now surpassed five million installed units without a single recorded failure.

Not surprising considering the product carries all the most important approvals including UL508i, TUV (IEC 60947-1 & IEC 60947-3), CE and CCC. In fact, the IMO SI solar isolator has been tested by some of the most rigorous examiners and OEM manufacturers in the world, passing with flying colours every single time.

As ever, the SI range has a guaranteed arc suppression time of 3mS, in built arc cooling chambers, operator independent switching mechanism and Safe-Lock handle, making it one of the safest DC isolators available, no matter who uses it or how slowly they operate it.

Why take a risk on safety? Insist on TRUE DC, contact us for a quotation and see why the IMO SI TRUE DC Isolator is the sensible choice for the PV installer.

Keep Solar Safe

SAFE-LOCK



SI Solar Isolators

TRUE DC Isolators for PV Systems

- Market-leading design
- 2, 4, 6 & 8 pole versions available
- Max. rated current 85A@1000VDC (acc. to DC21B/DC-PV1 for SI55)
- Range of mounting options
- Guaranteed arc suppression (3ms typical)
- Operator independent switching mechanism
- Knife-edge contacts



Innovators in TRUE DC isolation

Since its launch, the SI range of TRUE DC isolators has set the benchmark safety standard for disconnection and isolation of the DC panel load in solar applications world-wide. Prior to the introduction of the SI series, AC modified isolators in multi-pole linked form were commonly used with all the performance and safety issues that such devices presented.

The SI TRUE DC range was specifically developed to meet the needs of the solar industry with full operator independent switching mechanism, a guaranteed 5ms maximum arc suppression time and long-life knife edge contacts. Arc chambers built-in to the unit keep the device cool under repeated operation and the full range of mounting options provide a solution for almost every application.

Adopted as the standard by many of the largest solar equipment designers and installers around the world, the SI Series continues to set the benchmark in solar safety.

Additional Resources

There is only so much you can illustrate in printed form, so we have included a QR code which will take you directly to the Featured Spotlight for TRUE DC isolators on the IMO website. Here you will be able to watch a couple of videos about solar safety and recommendations from the Institution of Engineering & Technology in conjunction with the BRE National Solar Centre, about raising the bar for quality in the solar PV industry.



Ordering Variations

Lever Handle Models

Panel Mount (4-screw) 64 x 64 Escutcheon Plate Lever Handle, IP66, NEMA 3R	Single Hole Mount (22.5mm) 48 x 48 Escutcheon Plate Lever Handle, IP66, NEMA 4X	Base Mount (door coupling) 64 x 64 Escutcheon Plate Lever Handle, IP66, NEMA 4X	Modular Switch Lever Handle, IP40, NEMA 1
SI**PM64*	SI**SHM*	SI**BMD64*	SI**DB*

Lever Handle Models with Lockable OFF

Panel Mount (4-screw) 64 x 64 Escutcheon Plate Lockable Lever Handle, IP66, NEMA 3R	Single Hole Mount (22.5mm) 48 x 48 Escutcheon Plate Lockable Lever Handle, IP66, NEMA 4X	Base Mount (door coupling) 64 x 64 Escutcheon Plate Lockable Lever Handle, IP66, NEMA 4X	Modular Switch Lockable Lever Handle, IP40, NEMA 1
SI**PML64*	SI**SHML*	SI**BMDCL64*	SI**DBL*

Rotary Handle Models with Lockable OFF

Panel Mount (4-screw) 64 x 64 Lockable Rotary Handle, IP66, NEMA 4X	Base Mount (door coupling) 64 x 64 Lockable Rotary Handle, IP66, NEMA 4X	Enclosed Version Lockable Rotary Handle, IP67, NEMA 4X
SI**PM64R*	SI**BMD64R*	SI**PEL64R*

NOTE:

For description of each mounting mechanism please refer to pages 27 - 30.

IP ratings are for front panel and enclosed.

Part Number Configuration

SI	16	PM64R	2
Series	Switch Rating	Mounting Type	Number of Poles (see Switching Configurations on p.5)
SI DC Solar Isolator	16 Amp: 16 25 Amp: 25 32 Amp: 32 38 Amp: 38 40 Amp: 40 55 Amp: 55	Panel Mount (4-screw), 64 x 64 Escutcheon Plate, Lever Handle: PM64 Panel Mount (4-screw), 64 x 64 Escutcheon Plate, Lockable Lever Handle: PML64 Panel Mount (4-screw), 64 x 64 Lockable Rotary Handle: PM64R Single Hole (22.5mm) Mount, 48 x 48 Escutcheon Plate, Lever Handle: SHM Single Hole (22.5mm) Mount, 48 x 48 Escutcheon Plate, Lockable Lever Handle: SHML Base Mount (DIN Rail), 64 x 64 Escutcheon Plate, Lever Handle: BMD64 Base Mount (DIN Rail), 64 x 64 Escutcheon Plate, Lockable Lever Handle: BMDCL64	2: 2-Pole 2H: 2-Pole 4 Parallel Poles 4: 4-Pole 4S: 2-Pole 4 Poles in Series (Input Top, Output bottom) 4T: 2-Pole 4 Poles in Series (Input & Output bottom) 4B: 2-Pole 4 Poles in Series (Input & Output top) 6: 6-Pole 3H: 2-Pole 6 Parallel Poles 8: 8-Pole 4H: 2-Pole 8 Parallel Poles
		Base Mount (DIN Rail), 64 x 64 Lockable Rotary Handle: BMD64R Modular Switch, Lever Handle: DB Modular Switch, Lockable Lever Handle: DBL Enclosed Version, Lockable Rotary Handle: PEL64R	

Switching Configurations

Type	2-pole	2-pole 4 parallel poles	4-pole	2-pole 4 poles in series Input on top Output bottom	2-pole 4 poles in series Input and Output bottom	2-pole 4 poles in series Input and Output on top
SI16	2	2H	4	4S	4T	4B
SI25	2	2H	4	4S	4T	4B
SI32	2	2H	4	4S	4T	4B
SI38	2	2H	4	4S	4T	4B
SI40	2	2H	4	4S	4T	4B
SI55	2	2H	4	4S	4T	4B
Contacts Wiring Diagram						
Switching example						

Type	6-pole	2-pole 6 parallel poles	8-pole	2-pole 8 parallel poles
SI16	6	3H	8	4H
SI25	6	3H	8	4H
SI32	6	3H	8	4H
SI38	6	3H	8	4H
SI40	-	-	-	-
SI55	-	-	-	-
Contacts Wiring Diagram				
Switching example				

Approvals

Country	RoHS 	USA, UL508i 	US, Canada, UL508 	Europe CE 	CCC China 	IEC CB Europe
SI16	✓	✓	✓	✓	✓	✓
SI25	✓	✓	✓	✓	✓	✓
SI32	✓	✓	✓	✓	✓	✓
SI38	✓	Pending	Pending	✓	✓	✓
SI40	✓	✓	✓	✓	Pending	Pending
SI55	✓	✓	✓	✓	Pending	Pending

Insulated Jumper for series and parallel switching of contacts

Type	Jumper	Pack	Weight
SI16, SI25, SI32, SI38	SIV-B1	100	6.6g/pc.
SI40, SI55	SIV-B2	100	9.64g/pc.

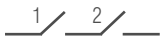
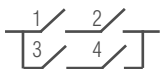
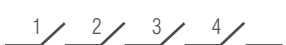
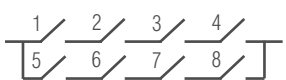

Technical Data for DC according to IEC 60947-3

Type		DC21B (DC-PV1)								DC22B			
		500V	600V	700V	800V	900V	1000V	1200V	1500V	500V	600V	800V	1000V
2 poles in series 	SI16 ..	16A	16A	16A	16A	16A	10A	7A	3A	7A	5.5A	2A	1A
	SI25 ..	25A	25A	25A	20A	17A	11.5A	8.5A	5A	8A	6A	2.5A	1.5A
	SI32 ..	32A	32A	32A	23A	20A	13A	10A	6A	9A	6.5A	3A	2A
	SI38 ..	45A	45A		30A		20A						
	SI40 ..	48A	48A	37A	35A	31A	29A	11A	7.5A				
	SI55 ..	55A	55A	55A	55A	43A	36A	17A	10A				
2 poles in series + 2 parallel 	SI16 ..	29A	29A	22A	17A	16A	10A	7A	3A				
	SI25 ..	45A	45A	27A	20A	17A	11.5A	8.5A	5A				
	SI32 ..	58A	55A	32A	23A	20A	13A	10A	6A				
	SI38 ..				30A		20A						
	SI40 ..	72A	68A	49A	42A	31A	29A	11A	7.5A				
	SI55 ..	85A	85A	77A	63A	43A	36A	17A	10A				
4 poles in series 	SI16 ..	16A	16A	16A	16A	16A	16A	16A	16A	16A	16A	11.5A	8A
	SI25 ..	25A	25A	25A	25A	25A	25A	25A	25A	25A	25A	25A	9A
	SI32 ..	32A	32A	32A	32A	32A	32A	32A	32A	32A	32A	32A	10A
	SI38 ..	45A	45A										
	SI40 ..	48A	48A	40A	40A	40A	40A	40A	40A				
	SI55 ..	55A	55A	55A	55A	55A	55A	55A	55A				
4 poles in series + 2 parallel 	SI16 ..	29A	29A	29A	29A	29A	29A	29A	20A				
	SI25 ..	45A	45A	45A	45A	45A	45A	33A	26A				
	SI32 ..	58A	58A	58A	58A	58A	58A	50A	32A				
	SI38 ..												
	SI40 ..	72A	72A	72A	72A	72A	72A	56A	42A	-	-	-	-
	SI55 ..	85A	85A	85A	85A	85A	85A	65A	55A	-	-	-	-

Technical Data for DC according to UL508i

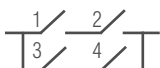
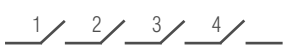
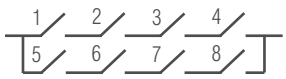
Type		UL508i						
		350V	500V	600V	700V	800V	900V	1000V
2 poles in series 	SI16 ..	16A	16A	16A	-	-	-	-
	SI25 ..	25A	25A	25A	-	-	-	-
	SI32 ..	32A	32A	32A	-	-	-	-
	SI38 ..	38A	38A	36A	-	-	-	-
	SI40 ..	40A	40A	40A	32A	26A	20A	16A
	SI55 ..	55A	55A	55A	46A	37A	28A	20A
2 poles in series + 2 parallel 	SI16 ..	29A	29A	21A	-	-	-	-
	SI25 ..	45A	38A	27A	-	-	-	-
	SI32 ..	58A	40A	32A	-	-	-	-
	SI38 ..	58A	45A	36A	-	-	-	-
	SI40 ..	72A	53A	42A	35A	30A	26A	22A
	SI55 ..	85A	66A	55A	47A	40A	32A	25A
4 poles in series 	SI16 ..	16A	16A	16A	-	-	-	-
	SI25 ..	25A	25A	25A	-	-	-	-
	SI32 ..	32A	32A	32A	-	-	-	-
	SI38 ..	38A	38A	36A	-	-	-	-
	SI40 ..	40A	40A	40A	40A	40A	40A	40A
	SI55 ..	55A	55A	55A	55A	55A	55A	55A
4 poles in series + 2 parallel 	SI16 ..	29A	29A	21A	-	-	-	-
	SI25 ..	45A	38A	38A	-	-	-	-
	SI32 ..	58A	58A	50A	-	-	-	-
	SI38 ..	58A	58A	50A	-	-	-	-
	SI40 ..	80A	71A	65A	58A	51A	45A	42A
	SI55 ..	85A	85A	85A	76A	71A	67A	64A

Technical Data

Data according to IEC 60947-3, VDE 0660, GB14048.3

Main Contacts		Type	SI16	SI25	SI32	SI38	SI40	SI55	
Rated thermal current I_{th}		A	16	25	32	45	40	55	
Rated insulation voltage $U_i^{(1)}$		V	1000	1000	1000	1000	1500	1500	
Rated insulation voltage $U_i^{(2)}$		V	1500	1500	1500	1500	1500	1500	
Distance of contacts (per pole)		mm	8	8	8	8			
Rated operational current I_e									
DC21A & DC21B	1 pole 1	300V A	16	23	27		40	55	
		400V A	12	14	16		30	44	
		500V A	9	10	13		19	32	
		600V A	6	7	10		15	25	
		700V A	4.5	5	7		10	18	
		800V A	3	4	5		8	13	
		900V A	2.5	3	4		6	10	
DC21B	2 poles in series 2	500V A	16	25	32		45	55	
		600V A	16	25	32		45	55	
		700V A	16	23	27		35	55	
		800V A	16	16	20		30	55	
		900V A	13	16	17		25	43	
		1000V A	9	10	11.5		20	36	
		1200V A	6	7	8.5		10	17	
	1500V A	3	4	5		6	10		
	2 poles in series + 2 poles parallel 2H	500V A	29	45	58		72	85	
		600V A	29	45	55		64	85	
		700V A	16	23	27		35	77	
		800V A	16	17	20		30	63	
		900V A	13	16	17		25	43	
		1000V A	9	10	11.5		20	36	
		1200V A	6	7	8.5		10	17	
1500V A	3	4	5		6	10			
3 poles in series + 2 poles parallel 3H	500V A	29	45	58		72	85		
	600V A	29	45	58		72	85		
	700V A	29	38	45		72	85		
	800V A	29	38	40		68	85		
	900V A	29	38	47		62	78		
	1000V A	29	38	45		58	70		
	1200V A	12	14	16		-	-		
1500V A	9	11	13		-	-			
4 poles in series 4S	500V A	16	25	32		45	55		
	600V A	16	25	32		45	55		
	700V A	16	25	32		40	55		
	800V A	16	25	32		40	55		
	900V A	16	25	32		40	55		
	1000V A	16	25	32		40	55		
	1200V A	16	25	32		40	55		
1500V A	16	20	23		30	55			
4 poles in series + 2 poles parallel 4H	500V A	29	45	58		72	85		
	600V A	29	45	58		72	85		
	700V A	29	45	58		72	85		
	800V A	29	45	58		72	85		
	900V A	29	45	58		72	85		
	1000V A	29	45	58		72	85		
	1200V A	29	45	50		56	65		
1500V A	16	20	23		42	55			
Rated operational current I_e									
AC21B	2, 4	U_e max. 440V	A	16	25	32	45	40	55
	2H	U_e max. 440V	A	29	45	58		72	85

1) Suitable at overvoltage category I to III, pollution degree 3 (standard-industry); $U_{imp} = 8kV$.

2) Suitable at overvoltage category I to III, pollution degree 2 (min.IP55); $U_{imp} = 8kV$.

Technical Data continued

Data according to IEC 60947-3, VDE 0660, GB14048.3

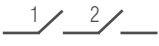
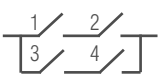
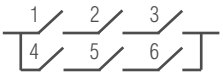
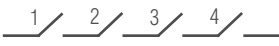
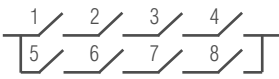
Main Contacts	Type	SI16	SI25	SI32	SI38	SI40	SI55	
Rated operational current I_e	300V A	16	23	27		40	55	
1 pole	400V A	14	22	25		33	44	
DC-PV1 	500V A	10	17	20		24	32	
	600V A	7	12	15		19	25	
	700V A	5	6	7.5		12	18	
	800V A	3	4	5		10	13	
	900V A	3	3	4		8	10	
	1000V A	2	2	3		5	8	
	2 poles in series 2 	500V A	16	25	32	45	48	55
		600V A	16	25	32	45	48	55
700V A		16	25	32		37	55	
800V A		16	20	23	30	35	55	
900V A		16	17	20		31	43	
1000V A		10	11.5	13	20	29	36	
1100V A		8	10	11.5		19	25	
1200V A		7	8.5	10	10	11	17	
1300V A		6	7	8		10	14	
1400V A		5	6	7		9	12	
1500V A		3	5	6	6	7.5	10	
2 poles in series + 2 poles parallel 2H 		500V A	29	45	58		72	85
		600V A	29	45	55		68	85
	700V A	22	27	32		49	77	
	800V A	17	20	23	30	42	63	
	900V A	16	17	20		31	43	
	1000V A	10	11.5	13	20	29	36	
	1100V A	8	10	11.5		19	25	
	1200V A	7	8.5	10	10	11	17	
	1300V A	6	7	8		10	14	
	1400V A	5	6	7		9	12	
	1500V A	3	5	6	6	7.5	10	
	3 poles in series + 2 poles parallel 3H 	500V A	29	45	58		72	85
		600V A	29	45	58	58	72	85
700V A		29	43	55	55	72	85	
800V A		29	40	51	51	68	85	
900V A		29	38	47	47	62	78	
1000V A		29	38	45	45	58	70	
1100V A		19	27	37		-	-	
1200V A		17	25	28	28	-	-	
1300V A		15	21	25		-	-	
1400V A		12	18	22		-	-	
1500V A		10	14	20	20	-	-	
4 poles in series 4S 		500V A	16	25	32	45	48	55
		600V A	16	25	32	45	48	55
	700V A	16	25	32		40	55	
	800V A	16	25	32		40	55	
	900V A	16	25	32		40	55	
	1000V A	16	25	32		40	55	
	1100V A	16	25	32		40	55	
	1200V A	16	25	32	32	40	55	
	1300V A	16	25	32		40	55	
	1400V A	16	25	32		40	55	
	1500V A	16	25	32	32	40	55	
	4 poles in series + 2 poles parallel 4H 	500V A	29	45	58		72	85
		600V A	29	45	58		72	85
700V A		29	45	58		72	85	
800V A		29	45	58		72	85	
900V A		29	45	58		72	85	
1000V A		29	45	58		72	85	
1100V A		29	45	54		60	68	
1200V A		29	45	50	50	56	65	
1300V A		26	39	44		50	61	
1400V A		23	33	38		46	58	
1500V A		20	26	32	32	42	55	

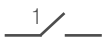
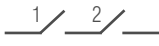
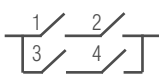
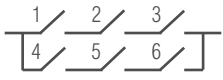
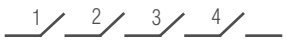
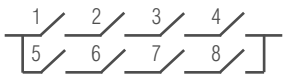

Technical Data continued

Data according to IEC 60947-3, VDE 0660, GB14048.3

Main Contacts	Type	SI16	SI25	SI32	SI38	SI40	SI55	
Rated operational current I_e	300V A	16	23	27		40	55	
1 pole	400V A	15	18	20		30	40	
DC-PV2 	500V A	10	12	14		19	25	
	600V A	5	6	8		10	13	
	700V A	1.5	2	3		7	10	
	800V A	1.5	2	3		6	8	
	900V A	1	1.5	2		5	6	
	1000V A	1	1.5	2		3	4	
	2 poles in series 2 	500V A	16	25	32		40	55
		600V A	14	21	27		40	55
700V A		13	19	22		35	55	
800V A		12	15	17		33	49	
900V A		8	10	12		25	35	
1000V A		4	5	6		16	20	
1100V A		3	4	5		11	15	
1200V A		2	3	4	4	8	12	
1300V A		1.5	2	3		7	10	
1400V A		1	2	3		7	9	
1500V A		1	1.5	2	2	6	8	
2 poles in series + 2 poles parallel 2H 		500V A	25	39	50		72	85
		600V A	20	32	35		60	75
	700V A	13	19	22		38	60	
	800V A	12	15	17		33	49	
	900V A	8	10	12		25	35	
	1000V A	4	5	6		16	25	
	1100V A	3	4	5		10	15	
	1200V A	2	3	4	4	8	12	
	1300V A	1.5	2	3		7	10	
	1400V A	1	2	3		7	9	
	1500V A	1	1.5	2	2	6	8	
	3 poles in series + 2 poles parallel 3H 	500V A					72	85
		600V A					72	78
700V A						62	69	
800V A						53	61	
900V A						44	55	
1000V A						35	50	
1100V A								
1200V A								
1300V A								
1400V A								
1500V A								
4 poles in series 4S 	500V A	16	25	32		40	55	
	600V A	16	25	32		40	55	
	700V A	16	25	32		40	55	
	800V A	16	25	32		40	55	
	900V A	16	25	32		40	55	
	1000V A	16	25	32		40	55	
	1100V A	16	25	32		40	55	
	1200V A	13.5	21	27		40	55	
	1300V A	12	19	24		36	50	
	1400V A	10.5	16	21		33	45	
	1500V A	9	14	18		30	40	
4 poles in series + 2 poles parallel 4H 	500V A	29	45	58	58	72	85	
	600V A	29	45	58	58	72	85	
	700V A	25	40	53	53	72	80	
	800V A	21	35	45	45	67	75	
	900V A	18	30	37	37	59	70	
	1000V A	16	25	32	32	52	64	
	1100V A					44	59	
	1200V A	13.5	21	27	27	40	55	
	1300V A					36	50	
	1400V A					33	45	
	1500V A	9	14	18	18	30	40	

Technical Data continued

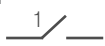
Data according to IEC 60947-3, VDE 0660, GB14048.3

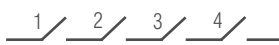
Main Contacts		Type	SI16	SI25	SI32	SI38	SI40	SI55
DC22B	1 pole 1 	500V A	1	1.25	1.5		x	2.5
		600V A	0.5	0.75	1		x	2
		800V A	0.3	0.4	0.5		x	1.5
		1000V A	0.15	0.2	0.25		x	1
		1200V A	-	-	-		x	x
		1500V A	-	-	-		x	x
	2 poles in series 2 	500V A	7	8	9		x	x
		600V A	5.5	6	6.5		x	x
		800V A	2	2.5	3		x	x
		1000V A	1	1.5	2		x	x
		1200V A	-	-	-		x	x
		1500V A	-	-	-		x	x
	4 poles in series 4S 	500V A	16	25	32		x	x
		600V A	16	25	27.5		x	x
		800V A	11.5	12	12.5		x	x
		1000V A	8	9	10		x	x
		1200V A	-	-	-		x	x
		1500V A	-	-	-		x	x
Rated conditional short-circuit current		kA _{eff}	5	5	5	5	10	10
Max. fuse size		gL (gG)	40	63	80	80	125	160
Mechanical Life		x10 ³	10	10	10		10	10
Rated short-time withstand current (1s)	I _{cw}	2, 4, 6, 8 A	800	900	1000	1000	2, 4: 1200	2, 4: 1400
		2H, 3H, 4H A	1300	1500	1700	1700	2H: 2000	2H:2400
Short circuit making capacity	I _{cw}	2, 4, 6, 8 A	800	900	1000	1000	2, 4: 1200	2, 4: 1400
		2H, 3H, 4H A	1300	1500	1700	17	2H: 2000	2H:2400
Maximum cable cross sections (including jumper)			SIV-B1				SIV-B2	
solid or stranded		mm ²	4 - 16	4 - 16	4 - 16	4 - 16	2.5 - 25	2.5 - 25
flexible		mm ²	4 - 10	4 - 10	4 - 10	4 - 10	4 - 16	4 - 16
flexible (+ multicore cable end)		mm ²	4 - 10	4 - 10	4 - 10	4 - 10	2.5 - 16	2.5 - 16
Size of terminal screw			M4 Pz2	M4 Pz2	M4 Pz2	M4 Pz2	M5 Pz2	M5 Pz2
Tightening torque		Nm	1.7 - 1.8	1.7 - 1.8	1.7 - 1.8	1.7 - 1.8	2.5 - 2.8	2.5 - 2.8
2 cables per clamp without jumper LSV-B1 / LSV-B2								
solid or stranded		mm ²	16+(1.5-2.5)/10+(1.5-6)/6+(1.5-10)/4+(1.5-10)				16+(1.5-2.5)/10+(1.5-10)/6+(1.5-10)/4+(1.5-10)	
flexible & flexible + multicore cable end		mm ²	16+(1.5-2.5)/10+(1.5-4)/6+(1.5-6)				16+(1.5-6)/10+(1.5-10)/6+(1.5-16)/4+(1.5-16)	
stranded		AWG	8+(16-12)/10+(16-10)/12+(16-8)/14+(16-8)				3+(18-10)/4+(18-10)/6+(18-8)/8+(18-8)	
solid		AWG	10+(16-12)/12+(16-10)/14+(16-10)				10+(16-10)/12+(16-10)/14+(16-10)/12+(16-10)/14+(16-10)	
Maximum ambient temperature								
Operation	All types except PEL64R	°C	-40 to +65					
	PEL64R type	°C	-40 to +45					
Storage		°C	-50 to +90					
Power loss per switch at I_{e max}			A	A	A		A	A
2	(A) / W	(16) / 1	(25) / 2.3	(32) / 3.7		(40) / 4	(55) / 7.5	
4	(A) / W	(16) / 2	(25) / 4.6	(32) / 7.4		(40) / 8	(55) / 15	
6	(A) / W	(16) / 3	(25) / 6.9	(32) / 11.1		(40) / 12	(55) / 22.5	
8	(A) / W	(16) / 4	(25) / 9.2	(32) / 14.8		(40) / 16	(55) / 30	
2H	(A) / W	(29) / 1.5	(45) / 3.7	(58) / 6		(72) / 6.5	(85) / 9	
3H	(A) / W	(29) / 2.3	(45) / 5.6	(58) / 9		(72) / 9.8	(85) / 14	
4H	(A) / W	(29) / 3	(45) / 7.4	(58) / 12		(72) / 13	(85) / 18	
Contact Resistance per pole		mΩ	1.75	1.75	1.75		1.25	1.25

x - In Test

Technical Data continued

Data according to UL508i  File E362605 and UL508  File E146487, Category no.: NRNT2, NRNT8

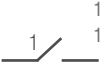
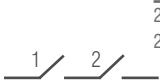
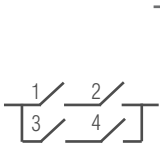
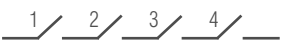
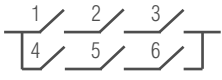
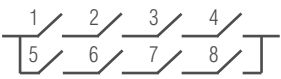
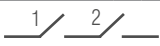
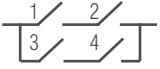
Main Contacts	Type	SI16	SI25	SI32	SI38	SI40	SI55
Ampere-Rating "General Use"							
 1 pole	DC						
	350V A	4	5	6	6	7.1	10
	500V A	4	5	6	6	5.7	7
	600V A	4	5	6	6	5	5.8
	700V A					3.9	5
	800V A					3.2	4.4
	900V A					2.5	3.5
1000V A					1.5	2	
 2 poles in series	350V A	16	25	32	38	40	55
	500V A	16	25	32	38	40	55
	600V A	16	25	32	36	40	55
	700V A					32	46
	800V A					26	37
	900V A					20	28
	1000V A					16	20
 2 poles in series + 2 poles parallel 2H	350V A	29	45	58	58	72	85
	400V A					67	79
	500V A	29	38	40	45	53	66
	600V A	21	27	32	36	42	55
	700V A					35	47
	800V A					30	40
	900V A					26	32
1000V A					22	25	
 4 poles in series 4S	350V A	16	25	32	38	40	55
	500V A	16	25	32	38	40	55
	600V A	16	25	32	36	40	55
	700V A					40	55
	800V A					40	55
	900V A					40	55
	1000V A					40	55
 3 poles in series + 2 poles parallel 3H	350V A	29	45	58	58	72	85
	500V A	29	38	50	50	56	80
	600V A	21	38	45	45	52	65
	700V A					46	58
	800V A					40	51
	900V A					36	45
	1000V A					33	42
 4 poles in series + 2 poles parallel 4H	350V A	29	45	58	58	80	85
	500V A	29	45	58	58	71	85
	600V A	29	45	50	50	65	85
	700V A					58	76
	800V A					51	71
	900V A					45	67
	1000V A					42	64
AC Rating "General Use"							
2 poles in series	 600V A	16	25	32		40	55
2 poles in series + 2 poles parallel	 277V A			50		72	85
3 poles parallel	3x480V A			32		-	-
Fuse size (RK5) Industrial Control Switch							
5kA / 600V	A	40	60	80	80	-	-
5kA / 1000V	A					160	160
Maximum cable cross sections	(including jumper SIV-B1/B2)						
solid or stranded	AWG	12 - 10	12 - 10	12 - 10	12 - 10	16 - 10	16 - 10
flexible	AWG	12 - 6	12 - 6	12 - 6	12 - 6	14 - 4	14 - 4
flexible (+ multicore cable end)	AWG	12 - 6	12 - 6	12 - 6	12 - 6		
Size of terminal screw		M4 Pz2	M4 Pz2	M4 Pz2	M4 Pz2	M5 Pz2	M5 Pz2
Tightening torque	lb.inch	9 - 16	9 - 16	9 - 16	9 - 16	22 - 25	22 - 25

x - In Test

Technical Data continued

Switch SI16 2/4 poles all types except PEL64R

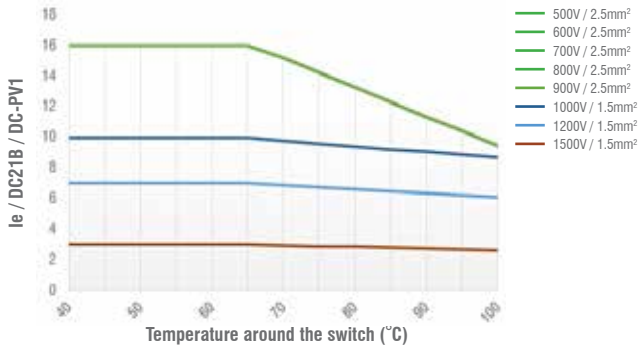

Switch SI16 2H all types except PEL64R

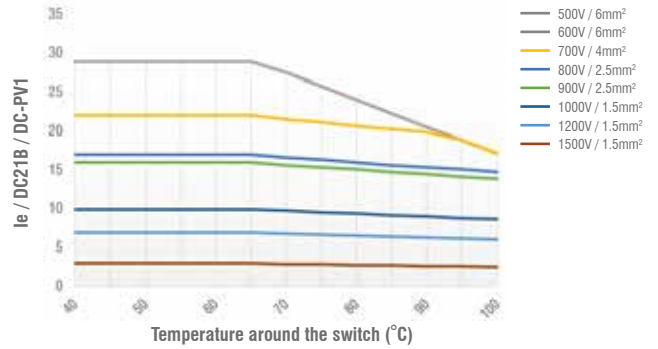

Switch SI16 4S all types except PEL64R

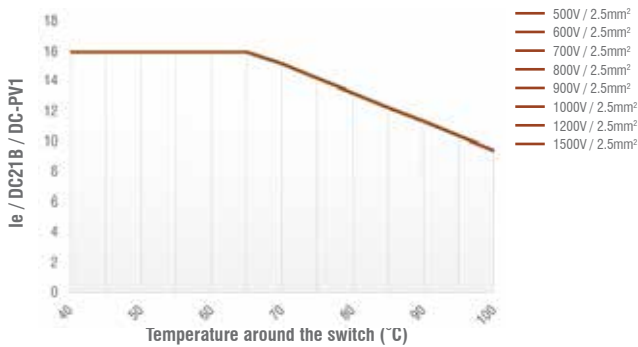

Switch SI16 4H all types except PEL64R

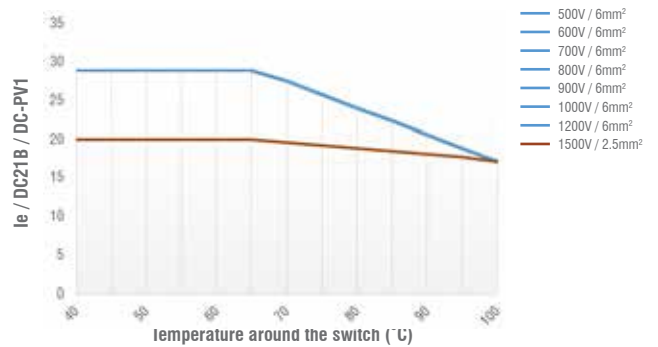

Switch SI16 2/4 poles PEL64R type

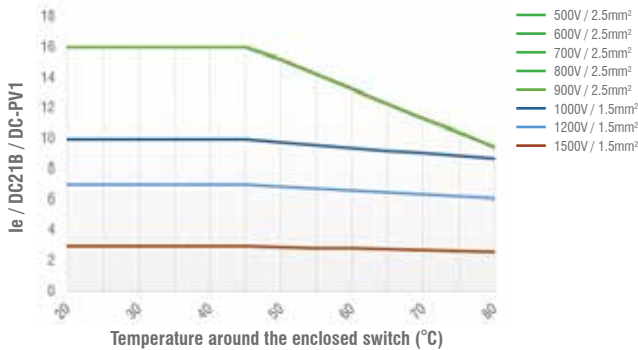

Switch SI16 2H PEL64R type

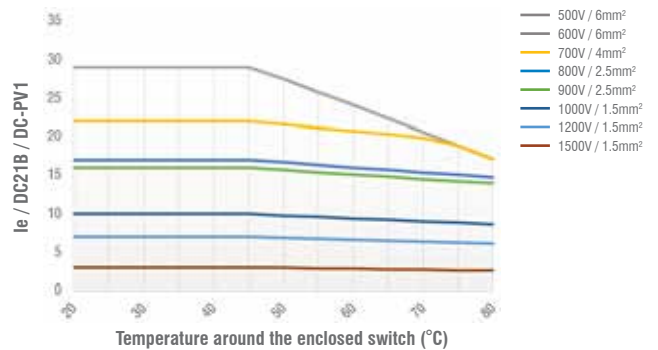

Switch SI16 4S PEL64R type

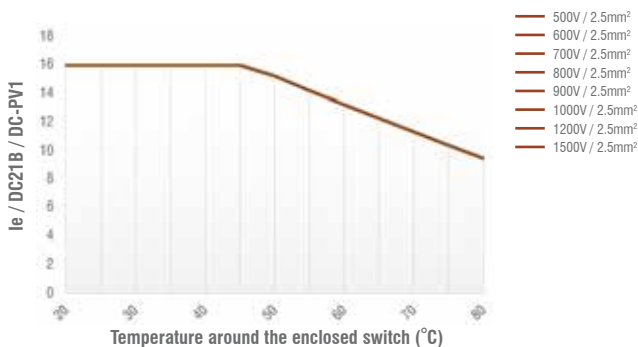

Switch SI16 4H PEL64R type

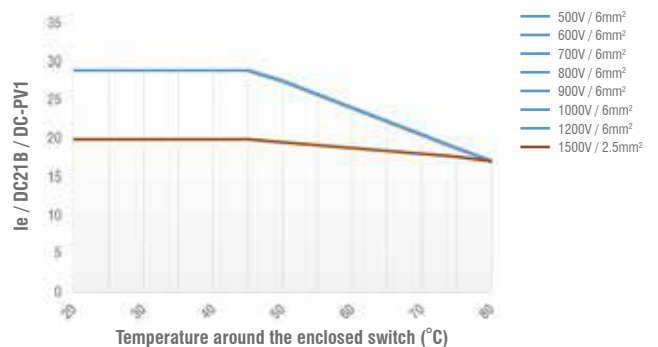

Technical Data continued

Switch SI25 2/4 poles all types except PEL64R

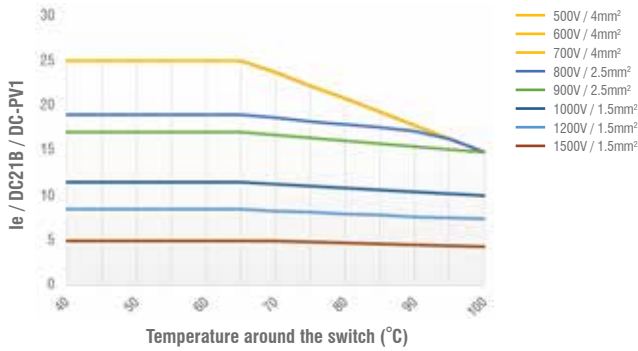

Switch SI25 2H all types except PEL64R

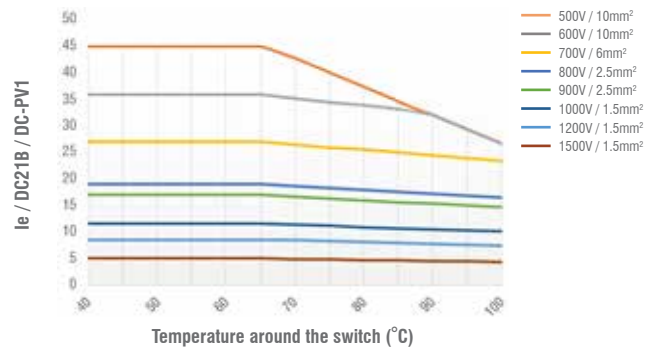

Switch SI25 4S all types except PEL64R

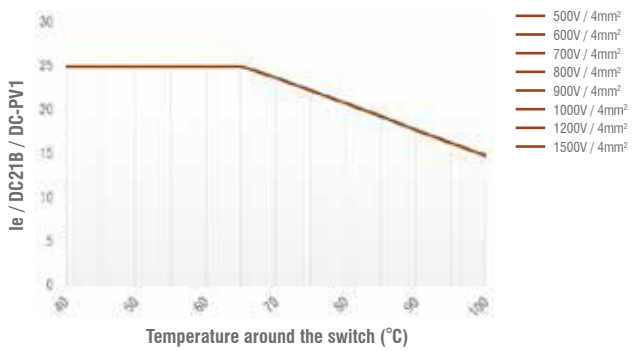

Switch SI25 4H all types except PEL64R

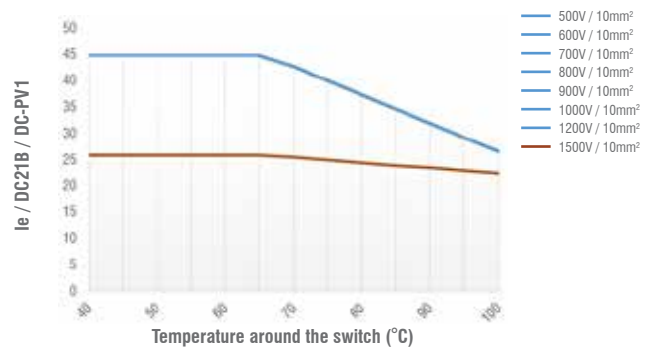

Switch SI25 2/4 poles PEL64R type

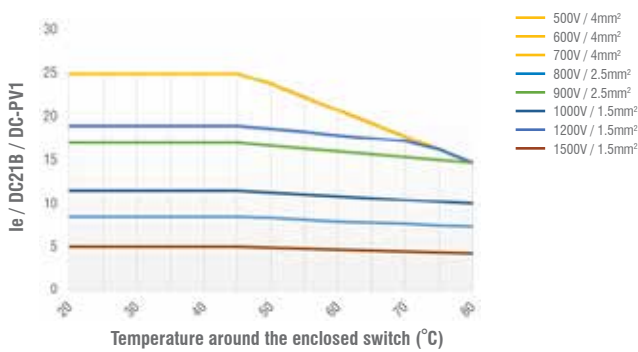

Switch SI25 2H PEL64R type

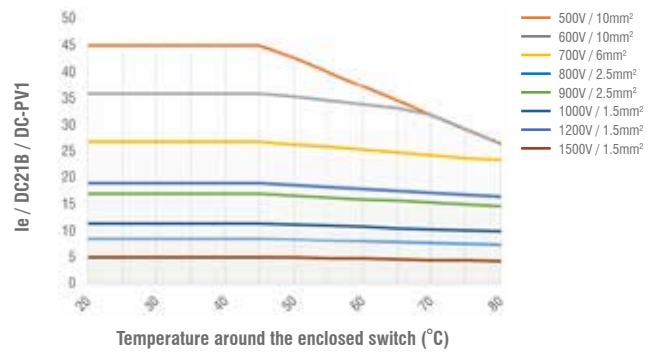

Switch SI25 4S PEL64R type

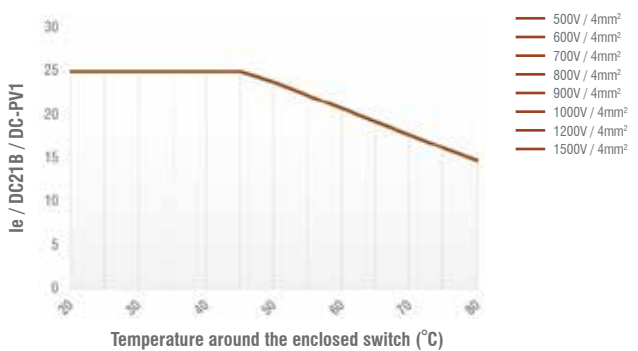

Switch SI25 4H PEL64R type

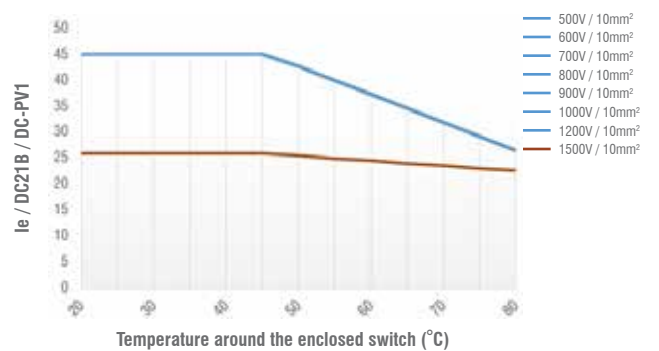

Technical Data continued

Switch SI32 2/4 poles all types except PEL64R

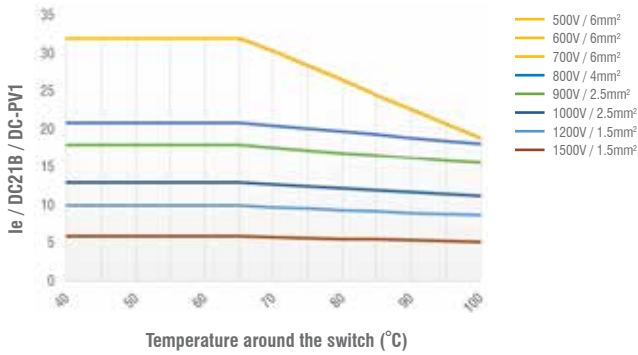

Switch SI32 2H all types except PEL64R

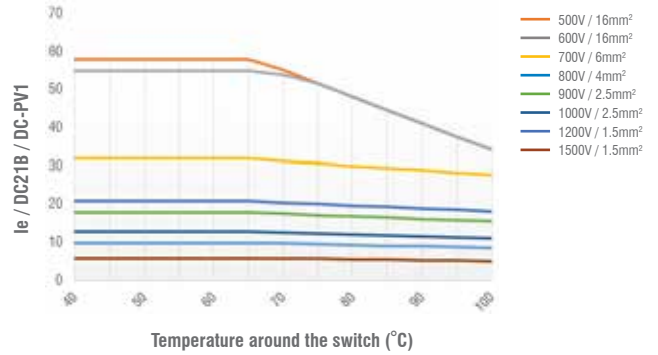

Switch SI32 4S all types except PEL64R

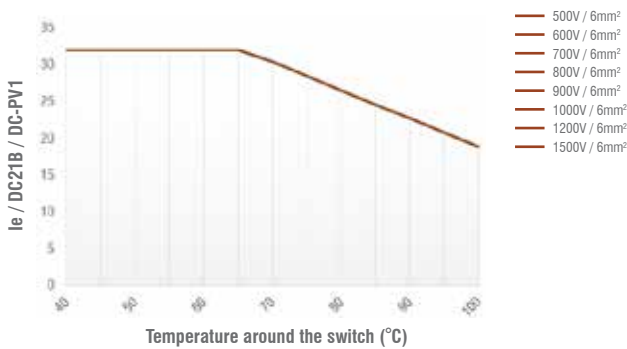

Switch SI32 4H all types except PEL64R

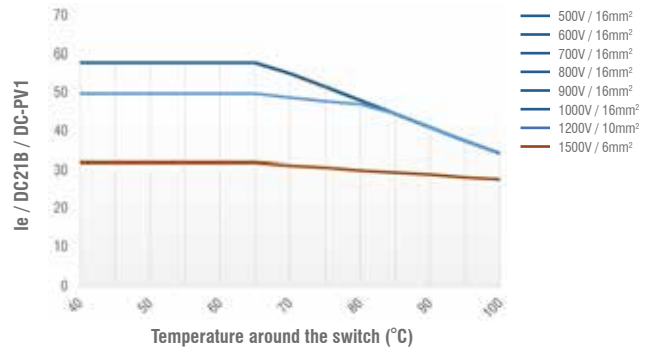

Switch SI32 2/4 PEL64R type

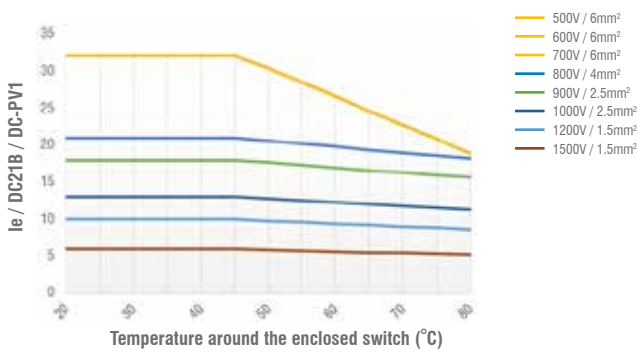

Switch SI32 2H PEL64R type

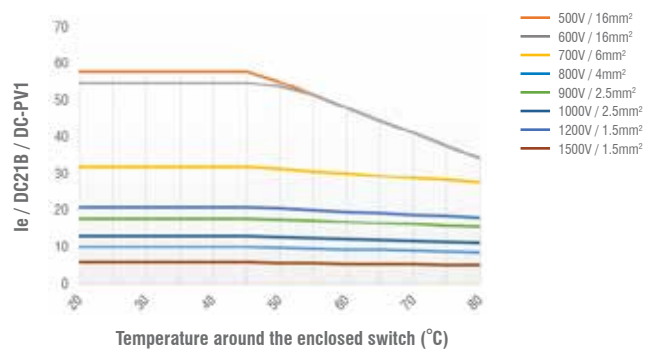

Switch SI32 4S PEL64R type

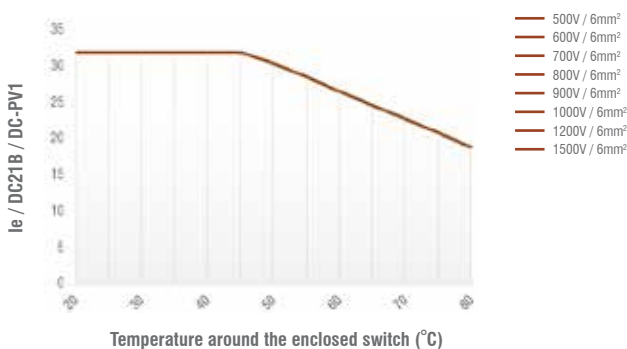

Switch SI32 4H PEL64R type

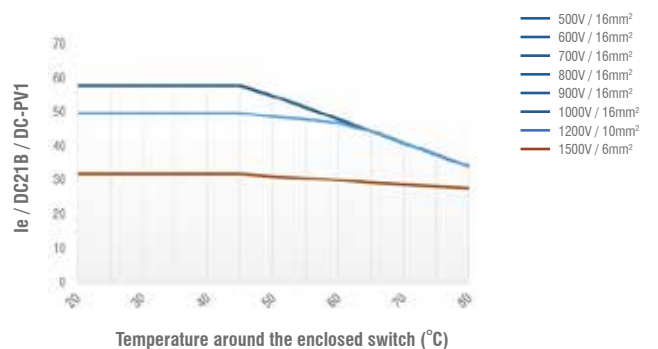

Technical Data continued

Switch SI40 2/4 poles all types except PEL64R

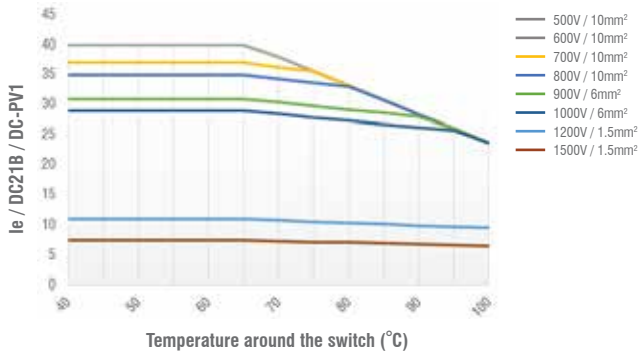

Switch SI40 2H all types except PEL64R

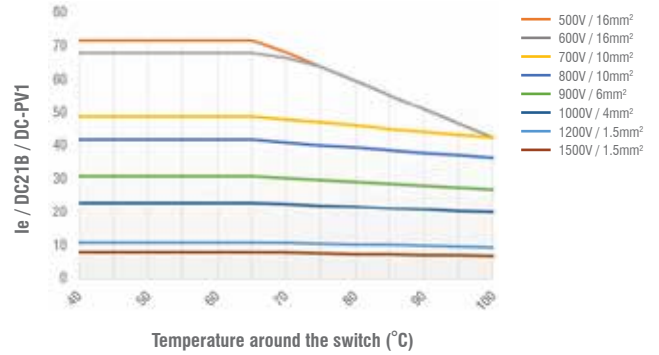

Switch SI40 4S all types except PEL64R

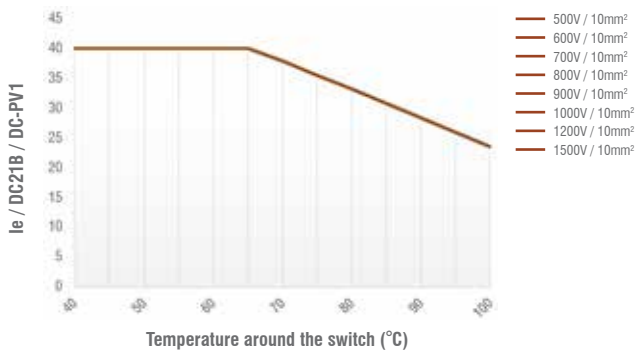

Switch SI40 2/4 poles PEL64R type

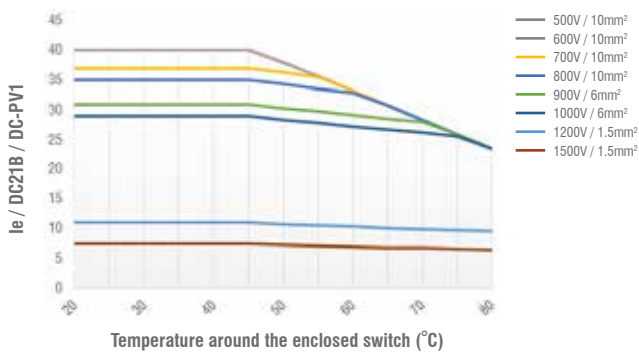

Switch SI40 2H PEL64R type

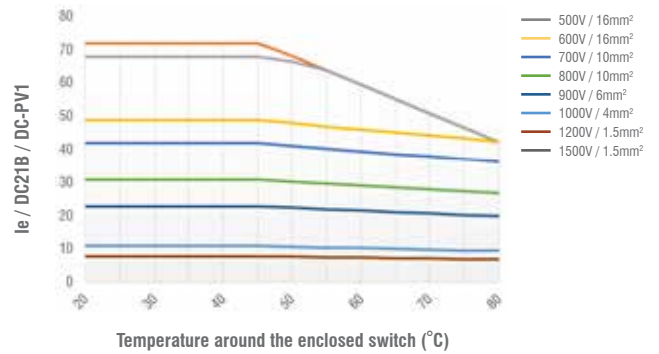

Switch SI40 4S PEL64R type

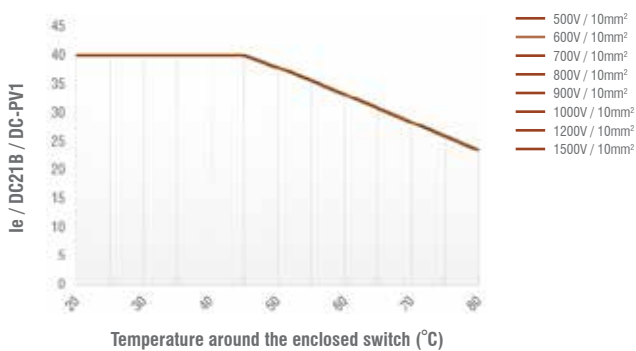

Technical Data continued

Switch SI55 2/4 poles all types except PEL64R

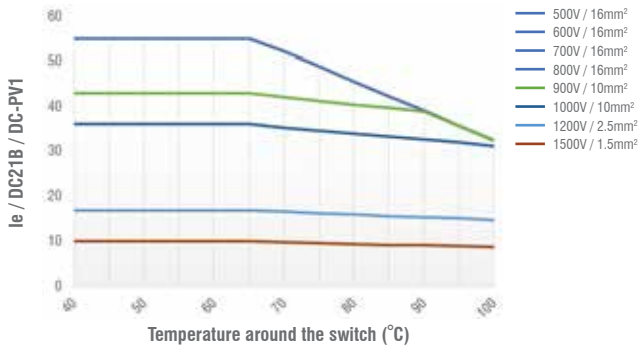

Switch SI55 2H all types except PEL64R

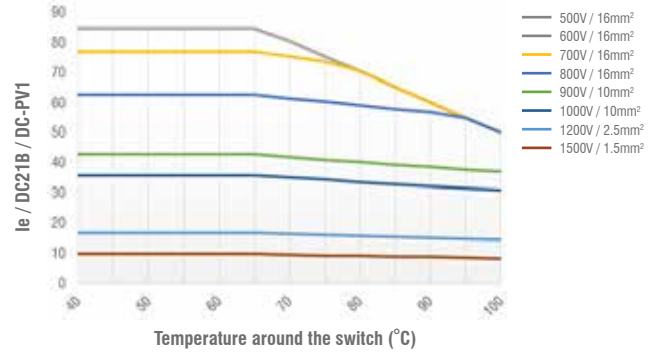

Switch SI55 4S all types except PEL64R

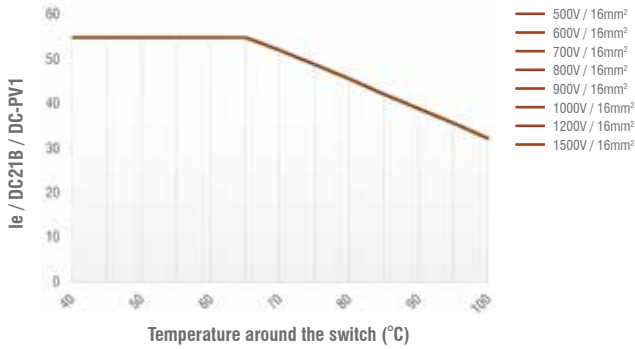

Switch SI55 2/4 poles PEL64R type

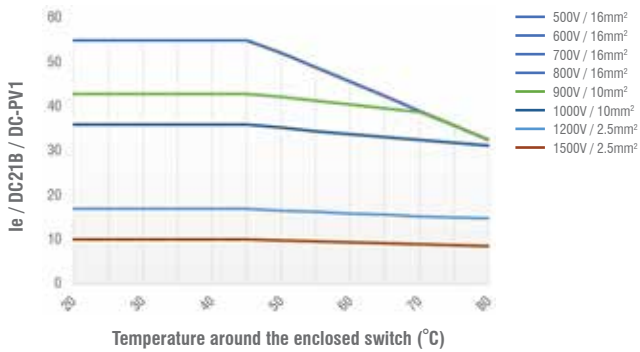

Switch SI55 2H PEL64R type

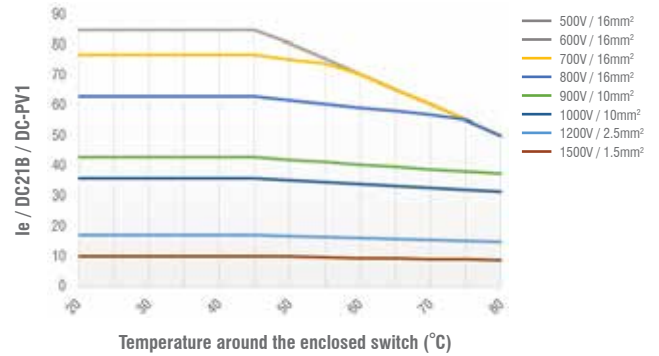

Switch SI55 4S PEL64R type

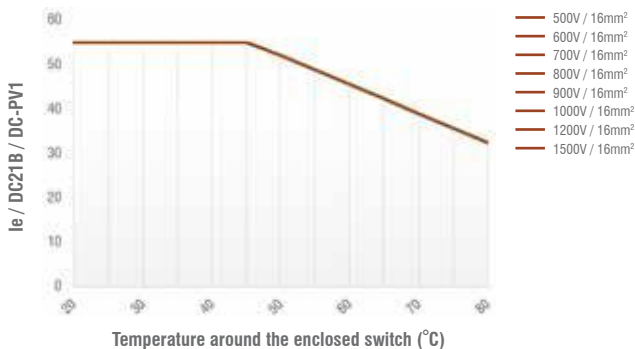

Dimensions (mm)

SI16PM / SI25PM / SI32PM / SI38PM
2
2H, 4

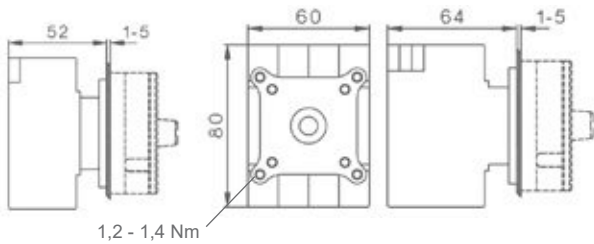

SI16PM / SI25PM / SI32PM / SI38PM
6, 3H, 8, 4H

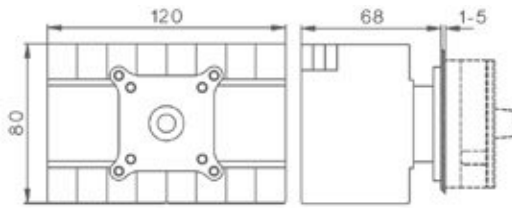

SI + X "Y"
Extended Switch Shaft

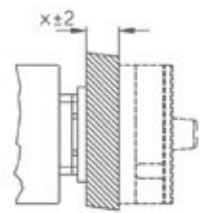

SI40PM / SI55PM
2, 2H, 4

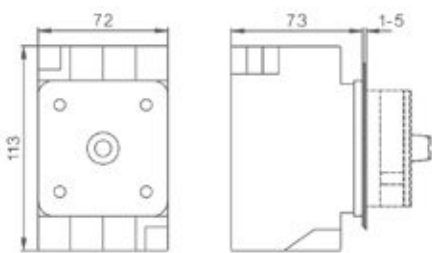

SI40PM / SI55PM
6, 3H, 8, 4H

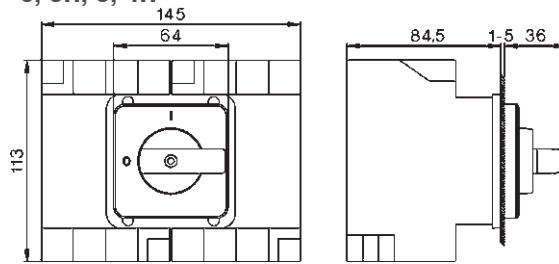

Mounting Hole

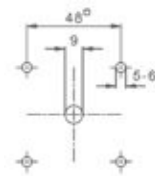

Escutcheon Plate 64

Lever



Lockable Lever

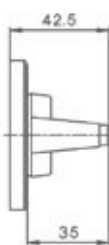
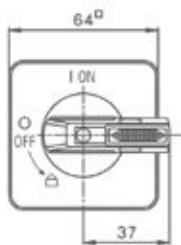

Lockable Rotary

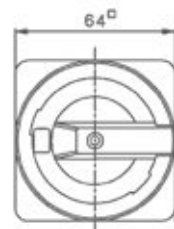

Panel Mounting

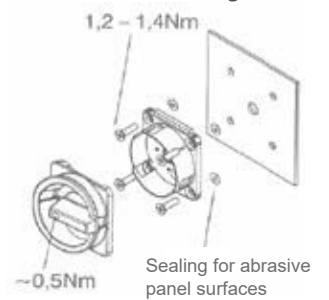

SI16SHM(L) / SI25SHM(L) / SI32SHM(L) / SI38SHM(L)
2

2H, 4

Mounting Hole

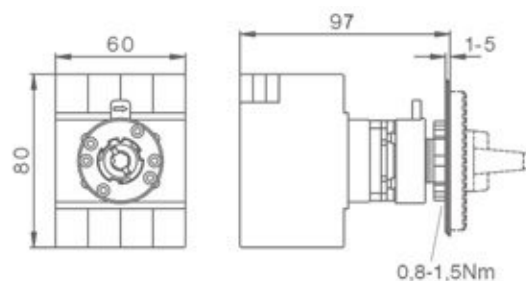
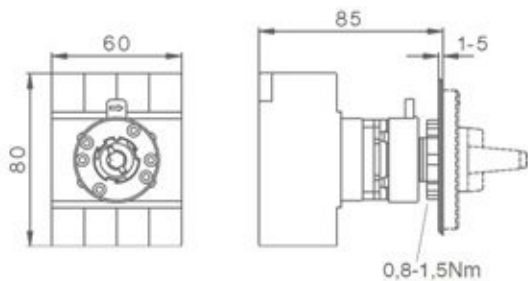

Escutcheon Plate 48

Lever Handle

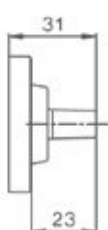

Lockable Lever

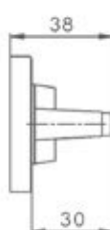
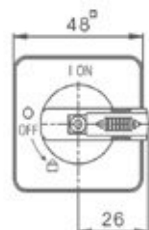

Dimensions (mm) continued

SI16SHM(L) / SI25SHM(L) / SI32SHM(L) / SI38SHM(L) 6, 3H, 8, 4H

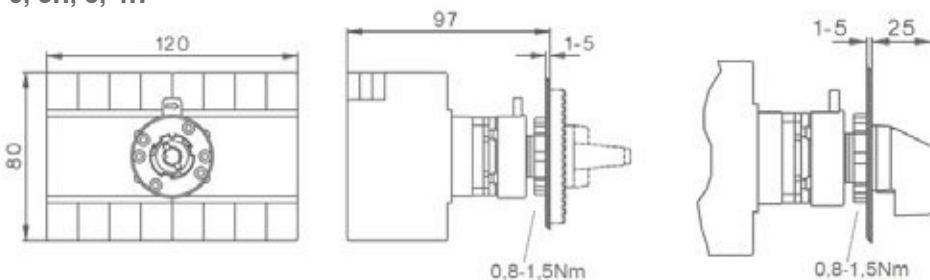

SI16BMDC / SI25BMDC / SI32BMDC / SI38BMDC 2H, 4

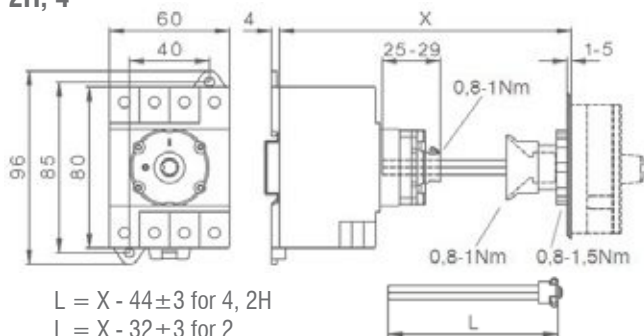

delivered with: 2H, 4
 $X_{max.} = 194$, $L = 150$
 $(X_{min.} = 89)$

delivered with: 2
 $X_{max.} = 182$, $L = 150$
 $(X_{min.} = 77)$

Greater X-Dimensions on request

$L = X - 44 \pm 3$ for 4, 2H
 $L = X - 32 \pm 3$ for 2

SI16BMDC / SI25BMDC / SI32BMDC / SI38BMDC 6, 3H, 8, 4H

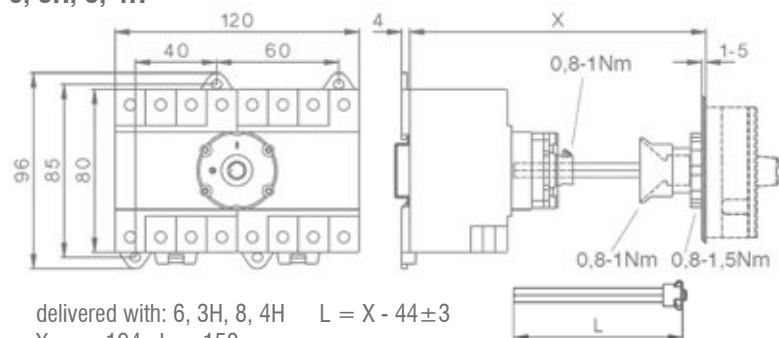

Mounting Hole

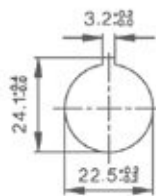

delivered with: 6, 3H, 8, 4H $L = X - 44 \pm 3$
 $X_{max.} = 194$, $L = 150$
 $(X_{min.} = 95)$

SI40BMDC / SI55BMDC 2, 2H, 4

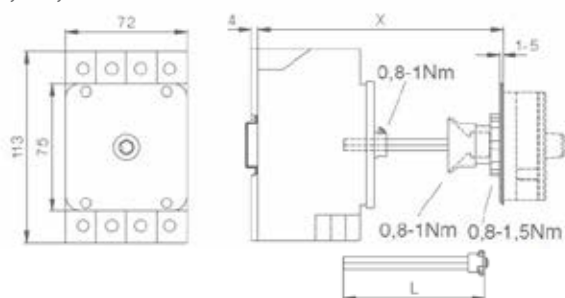

delivered with: 2, 2H, 4
 $X_{max.} = 194$, $L = 133$
 $(X_{min.} = 103)$

$L = X - 61 \pm 3$

SI40BMDC / SI55BMDC 6, 3H, 8, 4H

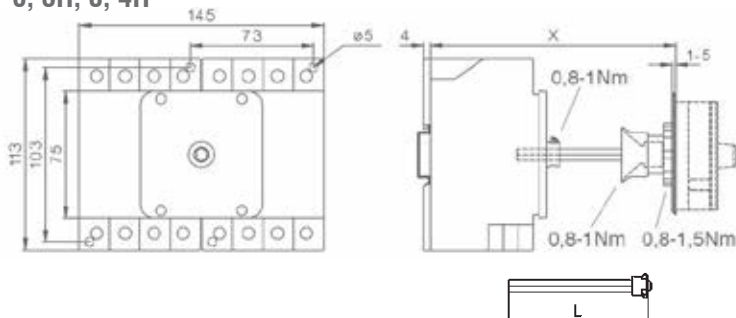

delivered with: 6, 3H, 8, 4H $L = X - 73 \pm 3$
 $X_{max.} = 194$, $L = 121$
 $(X_{min.} = 113)$

Dimensions (mm) continued

SI16DB(L) / SI25DB(L) / SI32DB(L) / SI38DB(L)

2

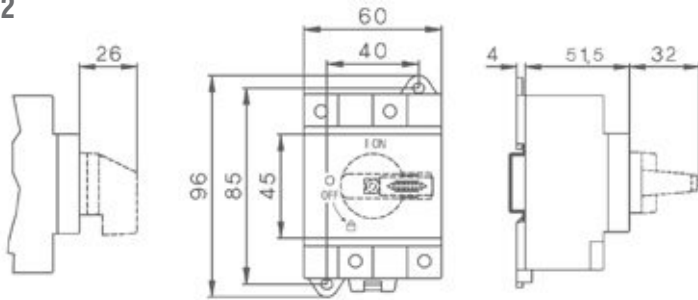

2H, 4

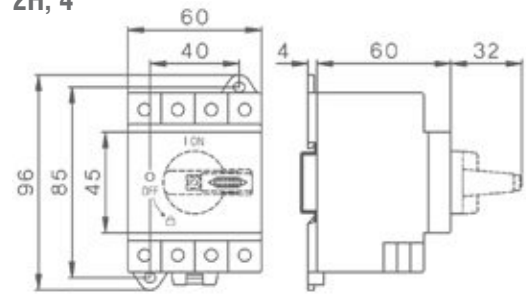

SI40DB(L) / SI55DB(L)

2, 2H, 4

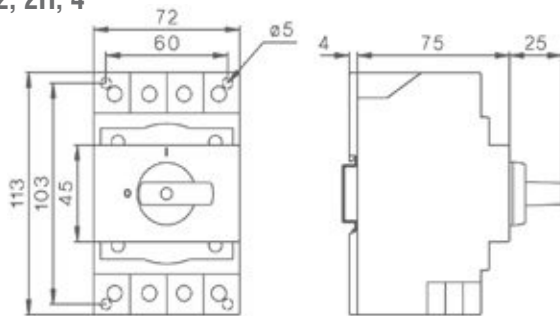

SI40DB(L) / SI55DB(L)

6, 3H, 8, 4H

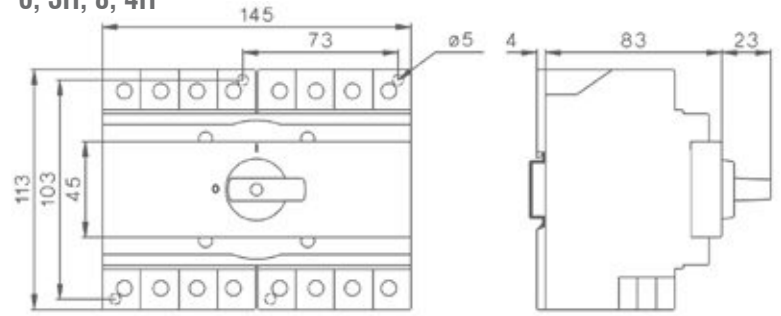

SI16DB(L) / SI25DB(L) / SI32DB(L) / SI38DB(L)

6, 3H, 8, 4H

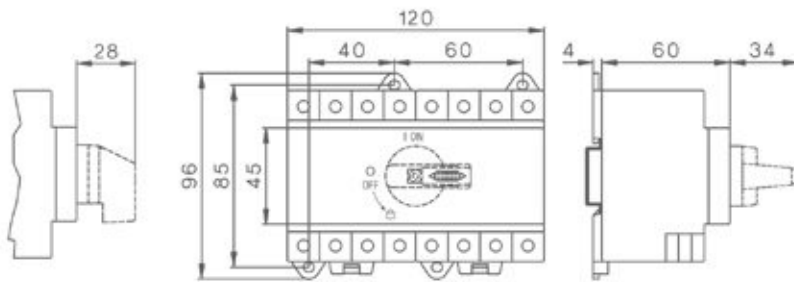

SI.. DBL with low height handle

2-LH

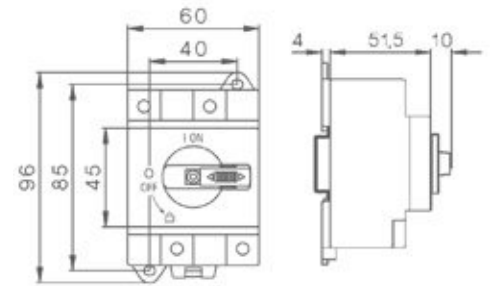

SI16DBL / SI25DBL / SI32DBL / SI38DBL with low height handle

2H-LH, 4-LH

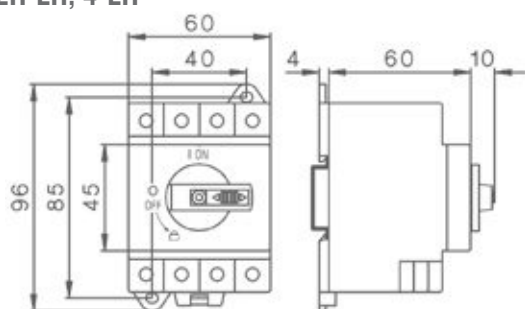

6-LH, 3H-LH, 8-LH, 4H-LH

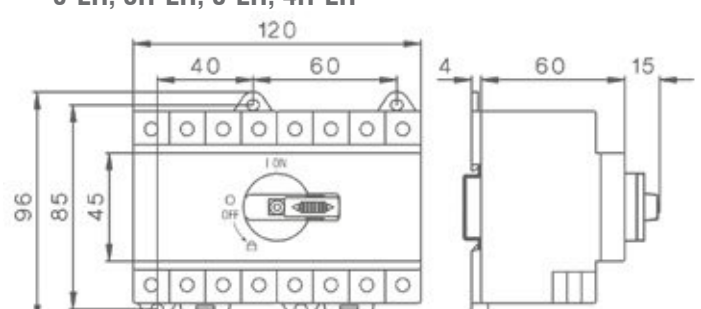

Dimensions (mm) continued

SI16PEL / SI25PEL / SI32PEL / SI38PEL
2, 2H, 4

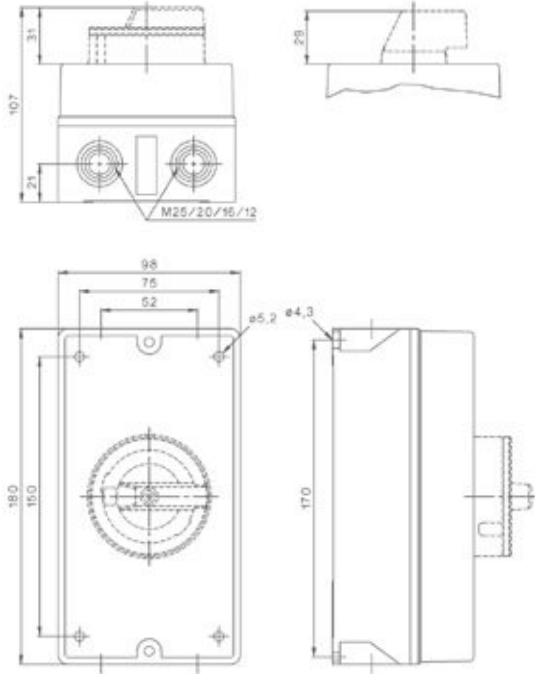

SI16PEL / SI25PEL / SI32PEL / SI38PEL
2, 2H, 4 + M25

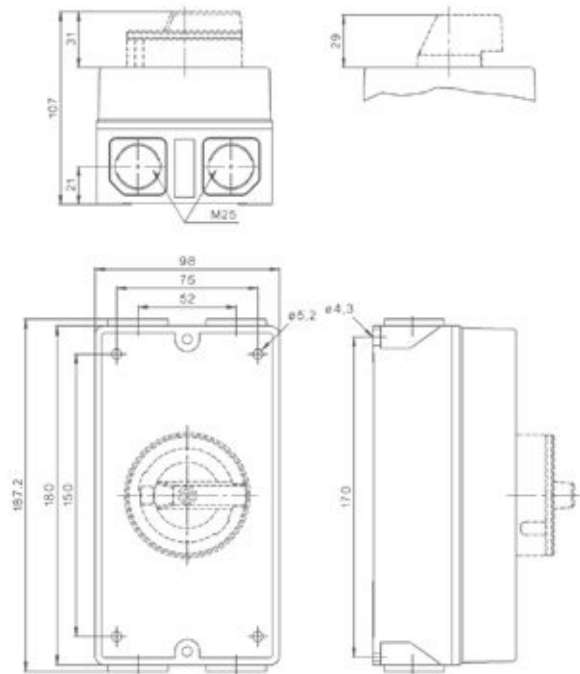

SI16PEL / SI25PEL / SI32PEL / SI38PEL
6, 8, 3H, 4H

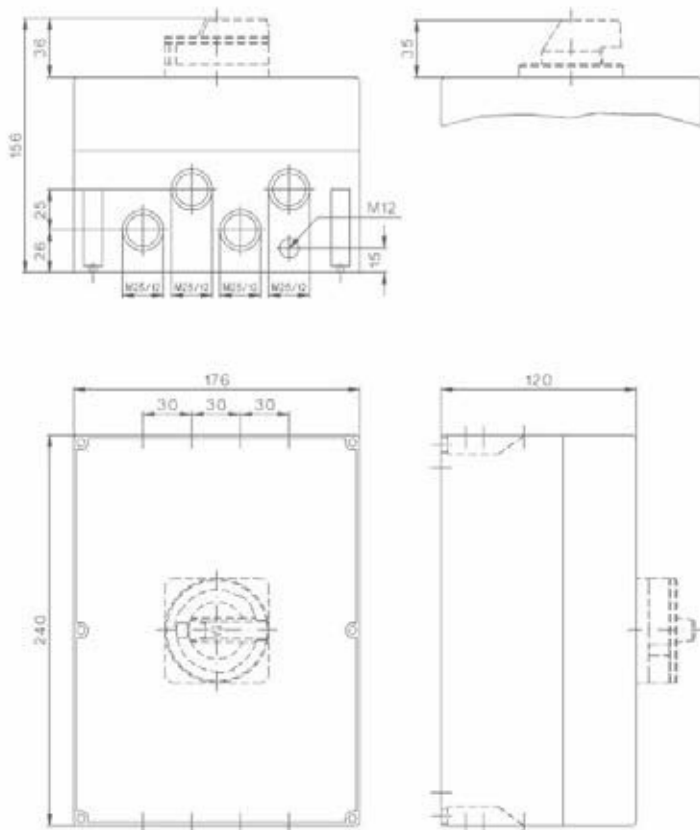

SI40PEL / SI55PEL
2, 2H, 4

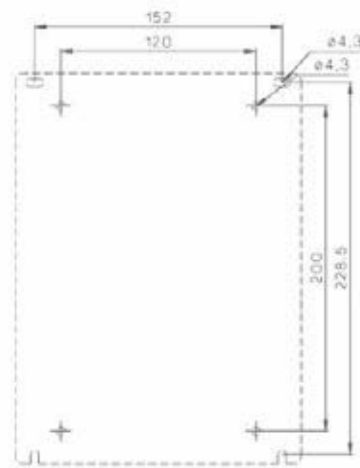

Also Available From IMO



AC Variable Speed Drives



SD1 Low-Cost Drives

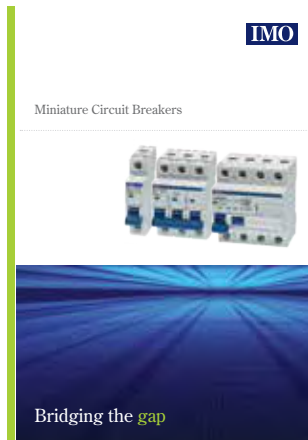

Miniature Circuit Breakers



Panel Product Range



Relays



PCB Terminal Blocks



DIN Rail Terminals

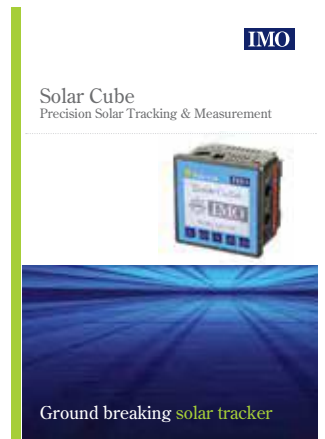

Solar Cube

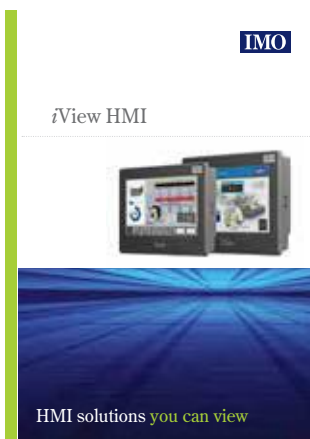

iView Advanced HMI

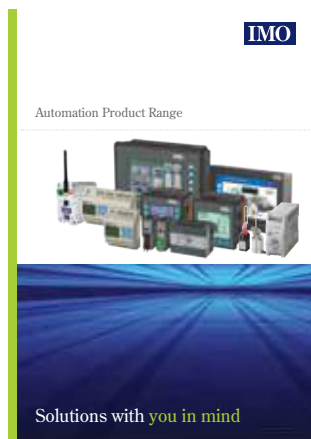

Automation Product Range



iConnect Remote M2M



FireRaptor Rapid Shutdown

IMO Worldwide Offices

IMO Precision Controls Limited

The Interchange
Frobisher Way
Hatfield, Herts AL10 9TG
United Kingdom

Tel: 01707 414 444
Fax: 01707 414 445
Email: imo@imopc.com
Web: www.imopc.com

IMO Jeambrun Automation SAS

5, Rue Alfred De Musset
94100
Saint-Maur-Des-Fosses
France

Tel: 0800 912 712 (n° gratuit)
Fax: 0145 134 737
Email: imo-fr@imopc.com
Web: www.imojeambrun.fr

IMO Automazione

Via Belfiore 10,
50144 Firenze (FI)
Italia

Tel: 800 930 872 (toll free)
Fax: 8000 452 6445
Email: imo-it@imopc.com
Web: www.imopc.it

IMO Canada

Unit 32 - B - North
18 Strathearn Avenue, Brampton
Ontario L6T 4Y2
Canada

Tel: 905 799 9237
Fax: 905 799 0450
Email: imo-ca@imopc.com
Web: www.imopc.com

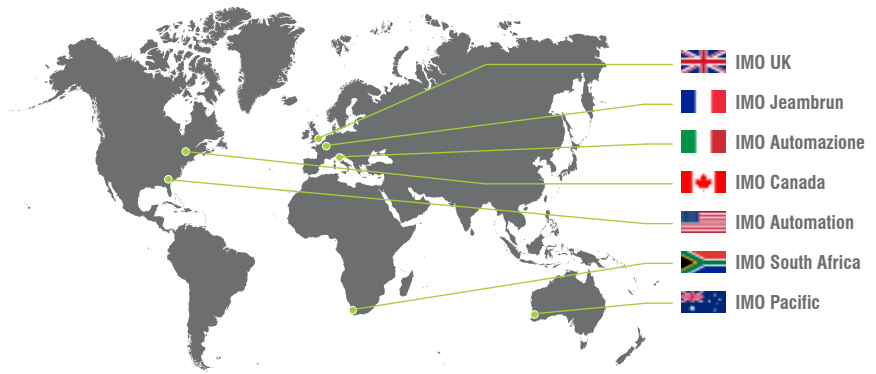

IMO Automation LLC

Steeplechase Industrial Park
Suite E, 5845 Steeplechase Blvd
Cumming, GA 30040
USA

Tel: 404 476 8810
Fax: 678 679 7112
Email: imo-usa@imopc.com
Web: www.imoautomation.com

IMO South Africa (Pty) Ltd

G16 Centurion Business Park
Montague Gardens
Cape Town 7441
South Africa

Tel: 021 551 1787
Fax: 021 555 0676
Email: info@imopc.co.za
Web: www.imopc.co.za

IMO Pacific Pty Ltd

Unit 9, Dillington Pass
Landsdale
Perth WA 6065
Australia

Tel: 08 9302 5246
Fax: 08 9303 9908
Email: sales@imopacific.com.au
Web: www.imopacific.com.au

LinkedIn

twitter

Connect with and follow IMO Precision Controls Ltd.
for the latest news, views and reviews